



## FIFE D-MAXE / OI-TS

### Operating Instructions

---



When requesting service or spare parts, please have ready the following reference number.

Bitte halten Sie bei Service- oder Ersatzteilanfragen die folgende Referenznummer bereit.

Pour toute demande d'intervention ou de pièces détachées merci de nous communiquer la référence suivante.

Si prega citare il seguente riferimento in caso di richiesta di assistenza tecnica o parti di ricambio.

Para cualquier petición de servicio o repuestos le rogamos nos comuniqué la siguiente referencia.



<b>INSTRUCTION</b>	<b>1-1</b>
About these operating instructions . . . . .	1-1
Proper use . . . . .	1-2
Options . . . . .	1-2
Improper use . . . . .	1-2
Operating principle . . . . .	1-3
Modules . . . . .	1-3
Operating principle . . . . .	1-3
<b>SAFETY INSTRUCTIONS</b>	<b>2-1</b>
Important information . . . . .	2-1
Information about safety instructions . . . . .	2-1
Symbols . . . . .	2-2
Preventing hazards . . . . .	2-2
Installation and commissioning . . . . .	2-2
Operation . . . . .	2-3
Maintenance . . . . .	2-3
<b>INSTALLATION</b>	<b>3-1</b>
Transport and storage . . . . .	3-1
Scope of delivery . . . . .	3-1
Option . . . . .	3-1
Mounting . . . . .	3-2
Installation location of D-MAX Controller . . . . .	3-2
Mechanical fastening of D-MAX Controller . . . . .	3-2
Installation location of D-MAX operator interface OI-TS . . . . .	3-3
Electrical connection . . . . .	3-5
Emergency Stop . . . . .	3-5
Power supply of D-MAX Controller . . . . .	3-5
Power supply of D-MAX operator interface OI-TS . . . . .	3-5
Connecting the sensors/actuators . . . . .	3-5
Connections on the D-MAX 1 Controller . . . . .	3-7
Connections on the D-MAX 2 Controller . . . . .	3-7
LEDs on the D-MAX Controller . . . . .	3-8
<b>OPERATOR INTERFACE OI-TS</b>	<b>4-1</b>
OI-TS description . . . . .	4-1
Buttons and Displays . . . . .	4-2
Header . . . . .	4-3
Select operator interface . . . . .	4-4
A Language . . . . .	4-4
B Select Device . . . . .	4-4
C Select Device Settings . . . . .	4-4
D OI Settings . . . . .	4-4
<b>OPERATING THE CONTROLLER</b>	<b>5-1</b>
User level . . . . .	5-1
Select devices/actuators . . . . .	5-2
Select operating modes . . . . .	5-2
Select jobs . . . . .	5-3
Shift guide point . . . . .	5-3
Moving the actuator . . . . .	5-4
Menu level . . . . .	5-4
<i>Job</i> menu . . . . .	5-5
Servo-Center menu . . . . .	5-6
Setup Menu . . . . .	5-7

<b>COMMISSIONING</b>	<b>6-1</b>
Before commissioning	6-1
Commissioning	6-1
<b>MENUS</b>	<b>7-1</b>
Notes	7-1
Menu identification	7-1
Conventions	7-1
2 Local Control	7-2
1y.3 Job	7-3
1y.3.y0 Calibrate sensors	7-3
1y.3.y1 Guidepoint	7-3
1y.3.y2 Auto Setup	7-4
1y.3.y3 Gain	7-4
1y.3.y4 OSC	7-4
1y.3.y5 PIC	7-4
1y.3.y6 ASC	7-4
1y.3.y7 Deadband	7-6
1y.3.y8 Polarity	7-6
1y.3.y9 Speed Gain Control	7-6
1y.3.y10 Actuator Speed	7-7
1y.4 Servo-Center	7-8
1y.4.1 Guidepoint	7-8
1y.4.2 Gain	7-8
1y.4.3 Polarity	7-8
1y.5 Hardware	7-9
1y.5.1 Sensors	7-9
1y.5.1.1 Sensor S1 X5/1	
...	
1y.5.1.4 Sensor S4 X9/2	7-9
1y.5.1.1.1 Calibration	7-10
1y.5.1.1.2 Type	7-11
1y.5.1.1.3 Field of View	7-11
1y.5.1.1.4 Sensor Supervision	7-11
1y.5.1.1.5 Current Range	7-12
1y.5.1.5 Line Speed	7-12
1y.5.1.7 Encoder	
...	
1y.5.1.8 Motor Encoder	7-12
1y.5.1._.1 Calibration	7-13
1y.5.1._.2 Travel Length	7-14
1y.5.1._.3 Search Reference	7-15
1y.5.1._.4 Clear Limits	7-15
1y.5.2 Actuator	7-15
1y.5.3 Digital Inputs	7-15
1y.5.4 Digital Outputs	7-15
1y.5.4.1 Digital Output A	
...	
1y.5.4.2 Digital Output B	7-16
1y.5.4._.1 Delay	7-16
1y.5.4._.2 <Set> State	7-16
1y.5.4._.3 <Cleared> State	7-16
1y.6 Control	7-17
1y.6.1 Modes	7-17
1y.6.2 Jobs	7-17
1y.6.3 Left/Right buttons	7-17
1y.6.3.1 Jog Enable	7-17
1y.6.3.2 Jog Direction	7-17

1y.6.3.3 Jog Speed	7-18
1y.6.3.4 Jog Soft Start	7-18
1y.6.4 Local Control	7-18
1y.6.5 Unit	7-18
1y.6.6 Hardlock	7-18
1y.6.6.1 Hardlock	7-18
1y.6.6.2 Gain	7-18
1y.6.6.3 Polarity	7-18
1y.7 Administration	7-19
Labels	7-19
Backup & Restore	7-19
Backup	7-19
Restore	7-20
1y.7.8.1 .. from previous backup	7-20
1y.7.8.2 .. factory settings	7-20
Device Names	7-20
1y.8 Network	7-21
<b>MAXNET Settings</b>	<b>7-21</b>
Customer Settings	<b>7-22</b>
1y.8.8 Distributed System	7-22
1y.9 Service	7-25
1y.9.1 Measurements	7-25
1y.9.1.1 Sensors	7-25
1y.9.1.2 Encoder	7-25
1y.9.1.3 Digital Inputs (Connection X1)	7-25
1y.9.1.7 Measured Values	7-25
1y.9.1.9 Sensor Current	7-25
1y.9.2 Simulate Outputs	7-25
<b>MAINTENANCE</b>	<b>8-1</b>
Maintenance work	8-1
<b>DECOMMISSIONING</b>	<b>9-1</b>
Decommissioning	9-1
<b>TROUBLESHOOTING</b>	<b>10-1</b>
Troubleshooting Procedure	10-1
Display possibilities	10-1
Procedure	10-1
LEDs on the D-MAX Controller	10-2
D-MAX operator interface OI-TS	10-3
Icons in the display of the D-MAX operator interface	10-4
Faulty behavior and setting errors	10-6
Possible causes for faulty behavior	10-6
Faulty behavior	10-9
<b>TECHNICAL DATA</b>	<b>11-1</b>
General information	11-1
D-MAX Controller	11-1
D-MAX operator interface OI-TS	11-1
Inputs and outputs of the D-MAX Controller	11-2
Parallel input matrix	11-4
Parallel output matrix	11-4
Jobs	11-5
Actuators	11-6
Cable lengths	11-8
Standards	11-8

---

Accessories (optional) .....	11-9
Input devices .....	11-9
Assembly accessories .....	11-9
<b>APPENDIX A – OVERVIEW</b>	<b>12-1</b>
<hr/>	
<b>APPENDIX B – SYMBOLS</b>	<b>13-1</b>
<hr/>	
<b>APPENDIX C – TERMS</b>	<b>14-1</b>
<hr/>	
<b>SERVICE</b>	<b>15-1</b>
<hr/>	

---

# 1 INTRODUCTION

---

---

## About these operating instructions

These operating instructions describe the installation, commissioning, operation and maintenance of the D-MAXE system with an operator interface OI-TS and provide important instructions for proper use.

These operating instructions are intended for both the system construction master as well as the operator who uses the D-MAX system in production. The Operating Instructions must be read and applied by everyone who is responsible for commissioning, operating or maintaining the D-MAXE systems.

The Operating Instructions must be carefully kept and must always be available throughout the service life of the D-MAXE system.



Note:

These Operating Instructions describe basic operation of the D-MAX systems. Additions and customer-specific adaptations are found in Supplementary Operating Instructions in the system documentation.

If the customer's system consists of multiple D-MAXE Controllers and/or operator interfaces, the instructions in these Operating Instructions must be performed separately for each module.

### **Translation of the original Operating Instructions:**

This Operating Instructions is a translation. The original Operating Instructions was composed in German.

---

**Proper use**

The D-MAXE System is used to control systems such as:

- Control roller systems
- Unwind and rewind systems
- Slitting systems
- Tool positioning systems

The D-MAXE system works in different functions:

- Edge guiding
- Center guiding
- Line guiding (edge or center guiding on printed lines).

The D-MAXE system must only be used in accordance with its intended purpose and must be in flawless technical condition. Unauthorized conversions or changes to the D-MAXE system are not permitted.

Any other use of the D-MAXE system requires the prior approval of Fife-Tidland GmbH.



**Note:**

The modules of the D-MAXE system must not be opened. If a module is opened, no claims under the warranty will be honored.

**Options**

Customer-specific programming and different sensors and actuators make it possible to adjust the D-MAXE system to a wide variety of applications.

---

**Improper use**

- Operation outside of the technical specifications is not permitted.
- Operation in areas where there is a danger of explosions is prohibited.
- Any use other than the designated use is not permitted.



## Operating principle

The D-MAXE system consists of various modules that can be combined depending on the specific application.

### Modules



Figure 1.1: D-MAXE Controller

### D-MAXE Controllers

- integrated into a guiding system or for wall mounting
- D-MAXE 1 Controller:  
for the drive of a control loop
- D-MAXE 2 Controller:  
For the drive of two independent control loops  
or  
one control loop with automatic sensor positioning



Figure 1.2: Operator interface

### D-MAXE Operator interfaces

- Operator interface OI-TS for desk installation or wall mounting:  
for operating of D-MAXE controllers or sensors
- PC-based virtual operator interface

## Operating principle

*Figure 1.3* shows an example of edge guiding (optionally center guiding) with a D-MAXE system. The D-MAXE system consists of a D-MAXE 1 Controller (1) and an operator interface OI-TS (2).

A sensor (3) senses the web edge of a material web and determines the current position of the web. The D-MAXE 1 Controller receives this information and guides the material web (5) by means of an actuator (4) so that it is always in the desired target position.

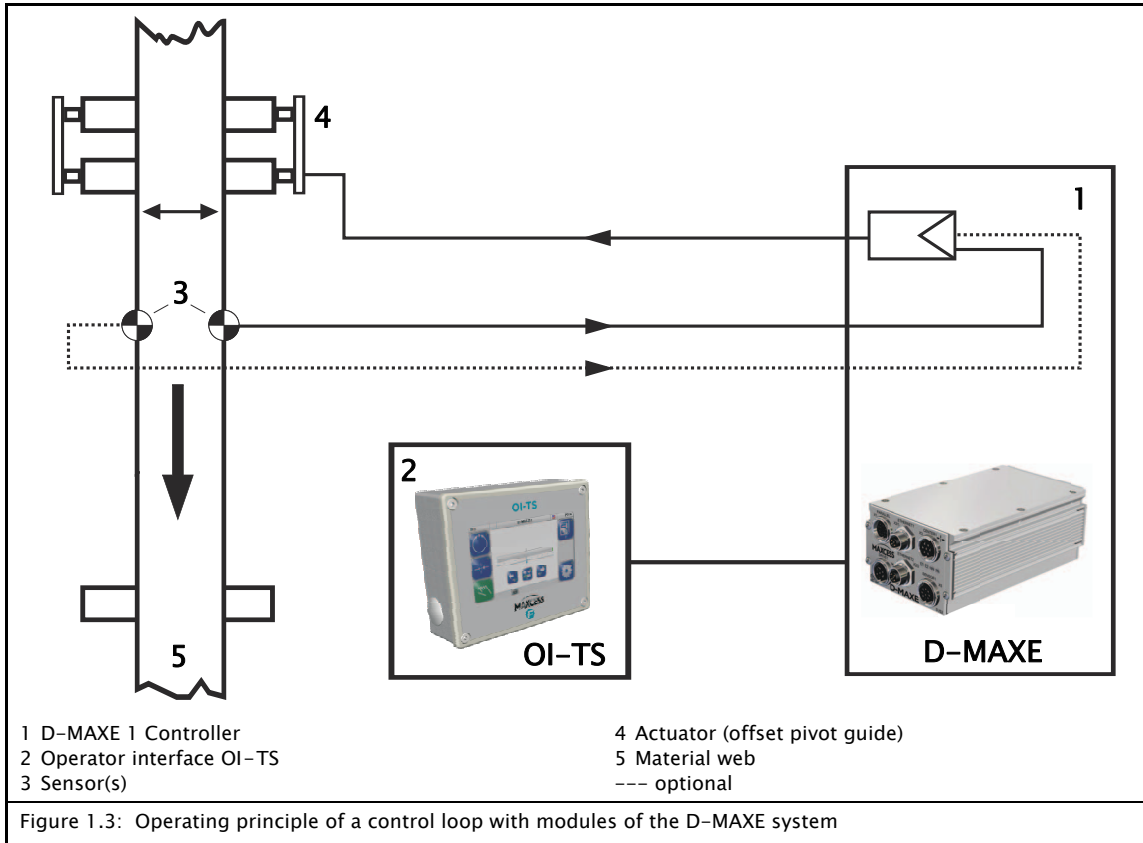

## 2 SAFETY INSTRUCTIONS

### Important information

Problem-free and reliable operation of the D-MAXE system requires that the D-MAXE system is

- properly shipped and stored,
- properly mounted and placed in operation,
- properly used and carefully maintained.

Proper operation and careful maintenance will ensure a long service life for the D-MAXE system.

Only persons who are acquainted with the installation, commissioning, operation and maintenance of the system and who possess the necessary qualifications for their activities may work on the D-MAXE system.



Please note the following:

- The content of these operating instructions
- The safety instructions printed on the unit
- The requirements of the machine manufacturer
- National, state and local requirements for accident prevention and environmental protection

### Information about safety instructions

The safety instructions and symbols described in this section are used in these Operating instructions. They are used to avoid possible dangers for users and to prevent material damage.



#### SIGNAL WORD

Source of danger and its results.

⇒ Avoiding dangers

The signal word **WARNING** refers to the danger of moderate to severe bodily injuries.

The signal word **CAUTION** refers to the danger of slight to moderate bodily injuries or material damage.

## Symbols



### Warning/caution – dangerous area

Reference to general hazards that may result in bodily injuries or damage to the device



### Warning/caution – danger due to crushing

Refers to danger of injury caused by crushing



### Warning/caution – danger due to cutting

Refers to danger of injury caused by cutting

### Additional symbols

- This endash is followed by an enumeration.
- This dot is followed by a prompt to do something.



### Note:

Reference to important information.

---

## Preventing hazards

### Installation and commissioning

- Damaged modules of the D-MAXE system must not be installed or placed in operation.
- Assembly work must be performed while the machine is stopped and protected against being turned on again.
- All assembly tasks must only be performed when there is no electrical power in the system.
- The D-MAXE system must only be placed in operation if all components are securely assembled.
- Electrical connections on the modules of the D-MAXE system must only be made or disconnected when the electrical power is turned off. Failure to follow these instructions may result in damage to the D-MAXE system.
- The parameters specified in Section *Technical Data* must be observed.

- Only replacement parts that have been approved by Fife-Tidland may be used.
- No changes may be made to the D-MAXE system.
- Electrical lines must not be subjected to any mechanical loads.

### Operation



- Danger of injury by crushing  
⇒ Do not place your hands on or near moving parts (rollers, material web, etc.) during operation.



- Danger of injury due to cutting on the edge of the material web  
⇒ Do not place your hands on the edge of the (moving) material web during operation.
- D-MAXE system modules damaged during operation must be decommissioned.

### Maintenance



- Danger of injury by crushing  
⇒ Maintenance work must only be performed on the D-MAXE system when the power is turned off, the machine is stopped, and it is protected against being turned back on.



# 3 INSTALLATION

## Transport and storage

- Modules of the D-MAXE system must be secured to prevent them from slipping during transport.
- The modules must be kept cool, clean and dry.
- Operator interfaces OI-TS must not be stored close to powerful magnetic fields. The electronic components of the device could be damaged.

## Scope of delivery

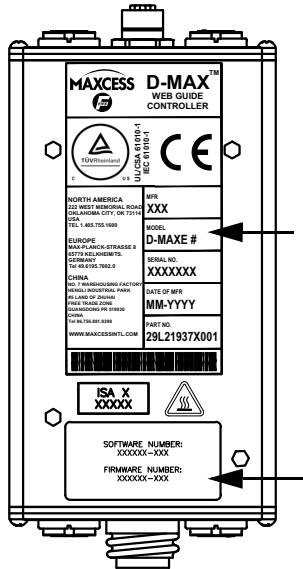

- D-MAXE Controller  
The model designation, serial number, and the firmware and software numbers are on the rating plates on the housing.
- Operating Instructions

## Option

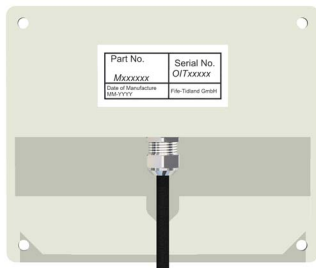

- Operator interface OI-TS  
The model designation and the serial number are on the rating plates on the housing. The firmware and software numbers are affixed to the side of the housing (see [figure 3.3, page 3-4](#)).
- Fastening materials for wall mounting
- Fastening material for installation in panel

## Mounting



### WARNING

- ⇒ All assembly tasks on the D-MAXE system must be performed when there is no electrical power in the system.
- ⇒ Assembly tasks and mechanical settings must only be performed when the machine has been stopped and secured from being turned on again.

### Installation location of D-MAXE Controller

- Protection class: IP54
- Operating temperature: 0°C ... 60°C
- Relative humidity: 10% to 90% non condensing
- Operating altitude above sea level: maximum 3000m
- On a fixed machine part or on a wall
- Not in places where there is a risk of explosions.

### Mechanical fastening of D-MAXE Controller

- Built into a guiding system or
- With an assembly bracket (optional) for wall mounting (see [figure 3.1](#)) or

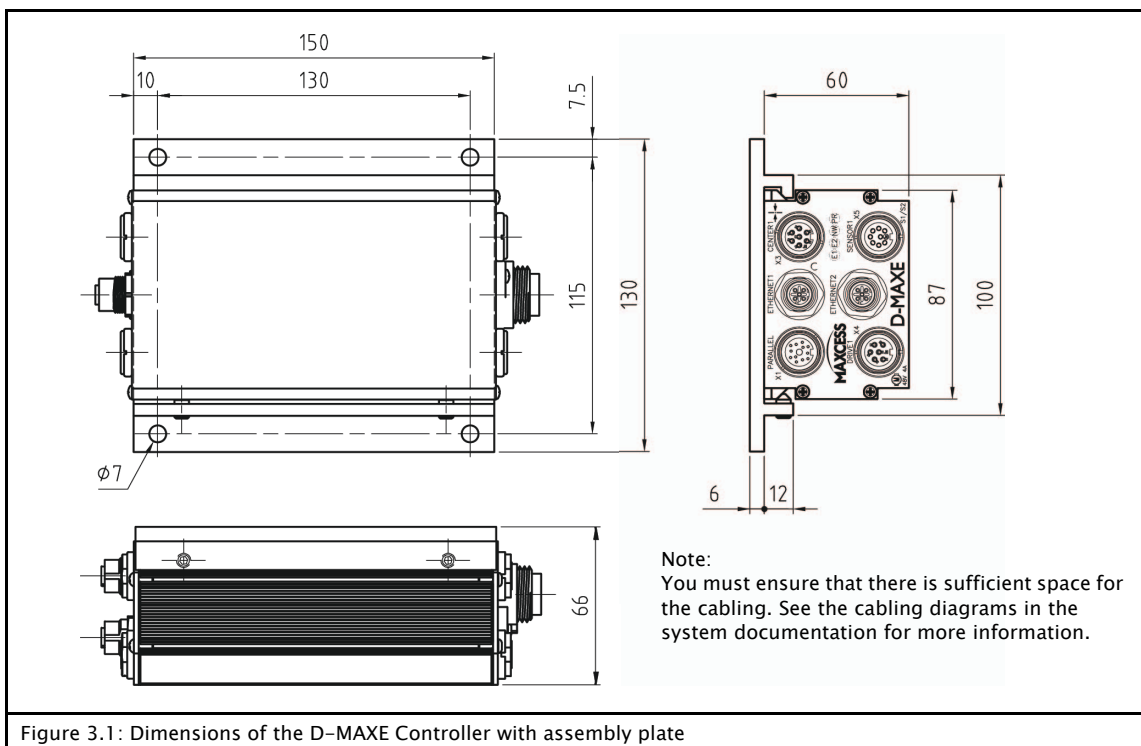
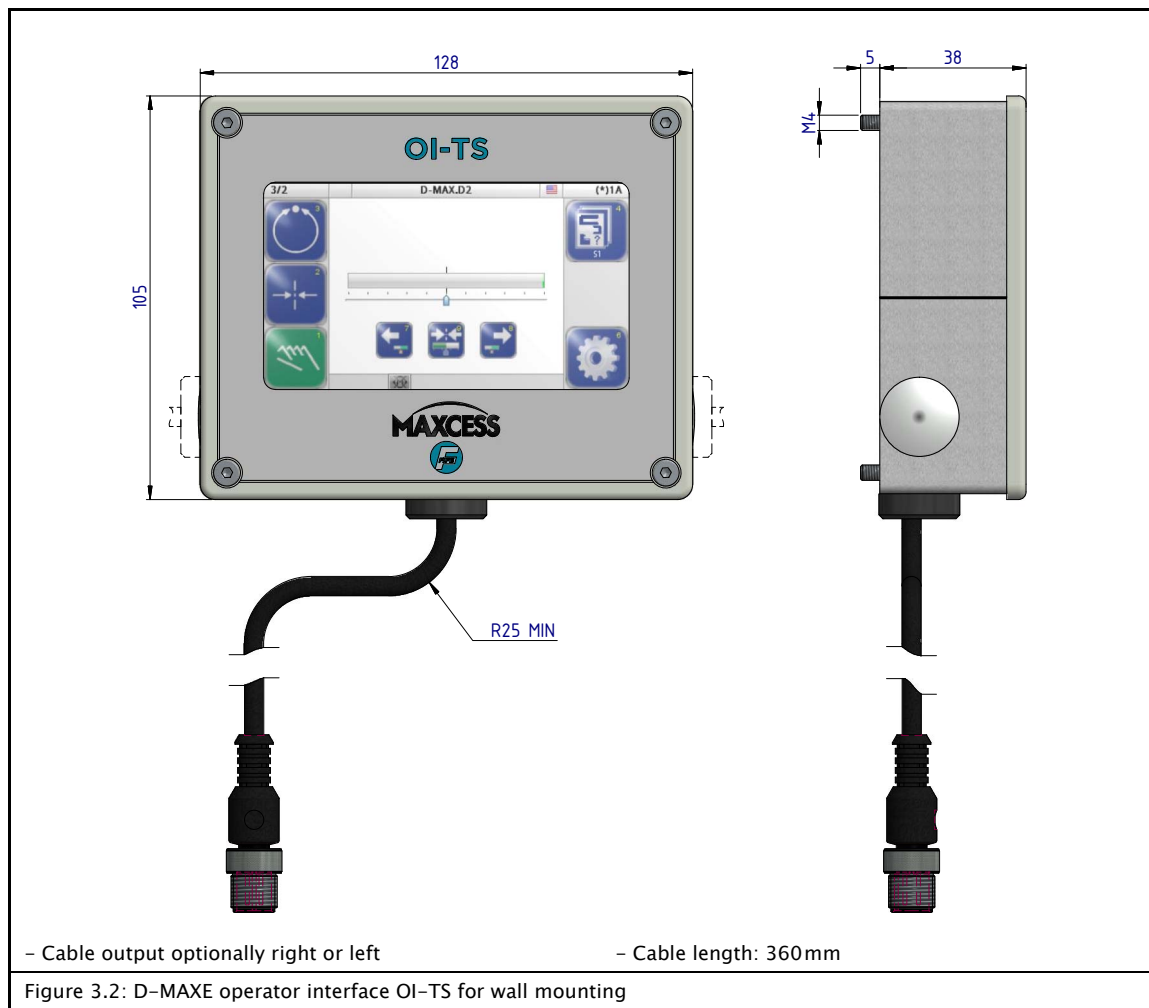

Figure 3.1: Dimensions of the D-MAXE Controller with assembly plate



**Installation location of  
D-MAXE operator interface  
OI-TS**

- Protection class: IP64
- Operating temperature: 0°C ... 60°C
- Relative humidity: 10% to 95% non-condensing
- Operating altitude above sea level: maximum 3000m
- On a fixed machine part or on a wall
- Protect from vibrations
- Do not place close to powerful magnetic fields:  
The electronic components may be damaged.
- Protect from falling objects:  
The operator interface can be damaged or an unintended switching process may be triggered.



Montage.fm

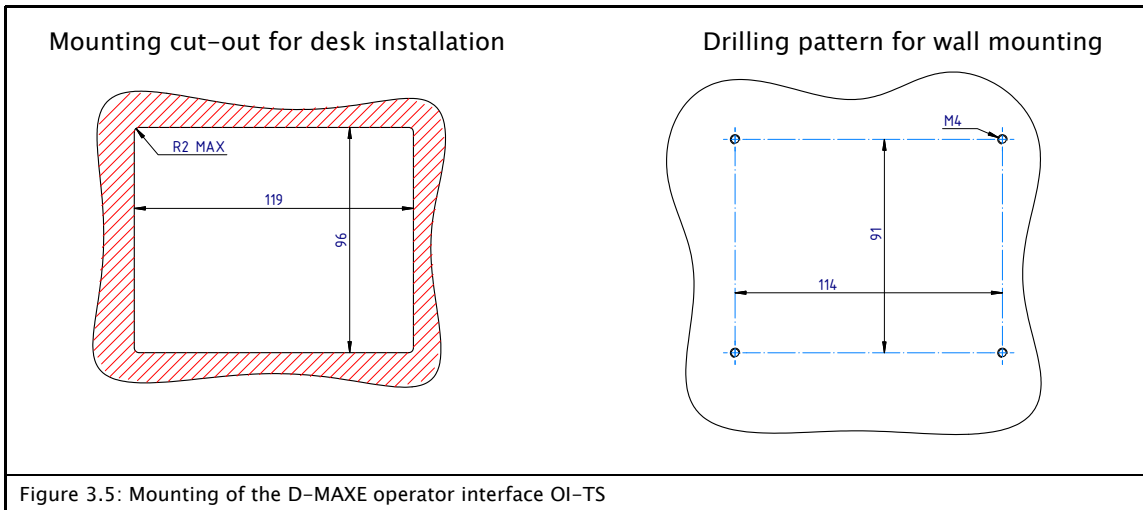
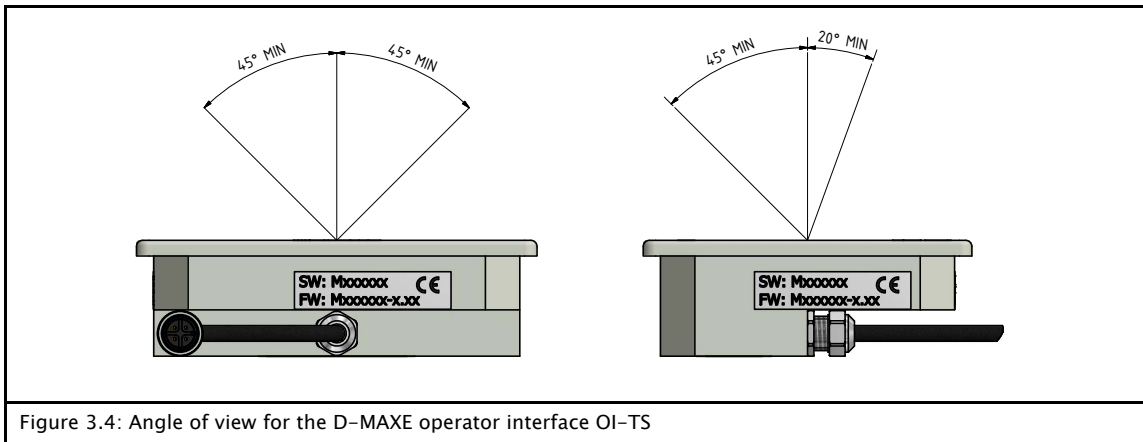
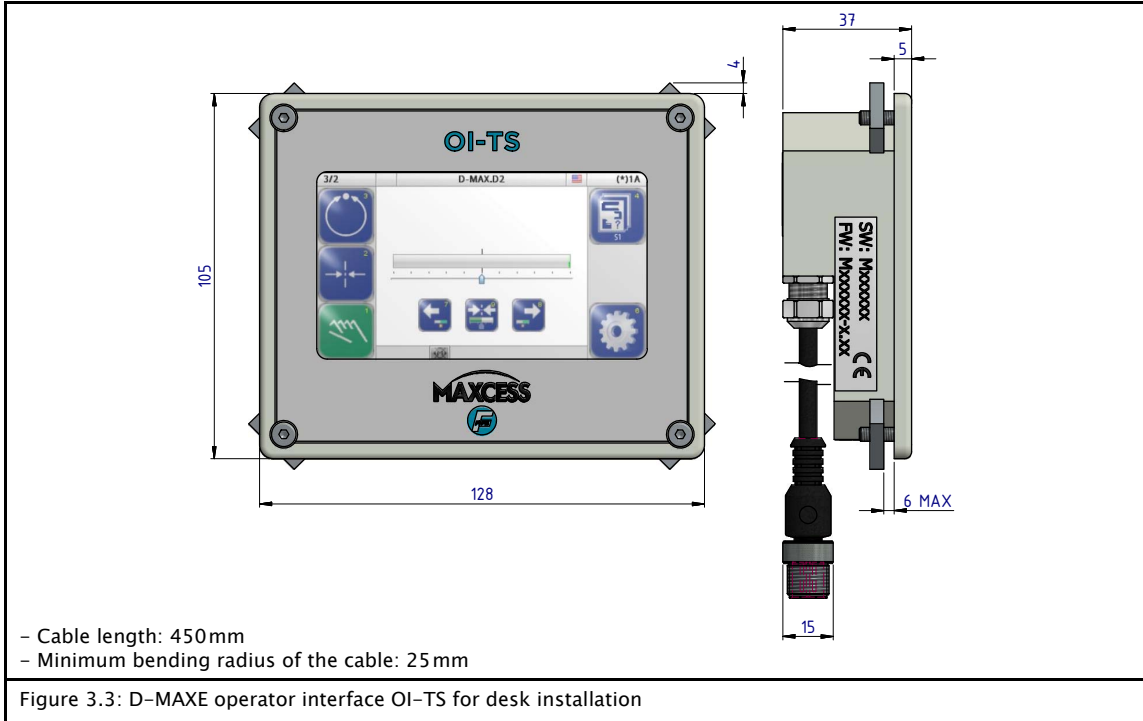

---

## Electrical connection

---

**CAUTION:**

Electrical connections on the D-MAXE system should always be made or disconnected while there is no electrical power in the system.

⇒ Failure to follow these instructions may result in damage to the D-MAXE system.

---

### Emergency Stop

The „D-MAXE Supplementary Operating Instructions – Safe shutoff of electromechanical actuators driven by a D-MAXE Controller” in the system documentation must be observed.

### Power supply of D-MAXE Controller

The D-MAXE Controller has no power switch. Because of this, the power supply of the D-MAXE Controller must be linked in to turn the flow of current to the machine on and off.

The D-MAXE Controller must be connected to the power supply according to the information supplied at connector X6 of the controller (see [figure 3.7](#) and [figure 3.8](#)).

### Power supply of D-MAXE operator interface OI-TS

The power supply for the D-MAXE operator interface OI-TS is via the signal cable, which is connected to the web guide controller at connector X8.

### Connecting the sensors/ actuators

- Only sensors and actuators approved by Fife-Tidland GmbH may be used.
- The technical data for sensors and actuators must match the connection data for the D-MAXE system (see [Technical Data, page 11-1](#)).
- Relevant operating instructions must be observed for installation and operation of sensors and actuators.
- Sensors and actuators must be connected to the D-MAXE system according to the system diagram in the system documentation.



**Note:**

Ensure that two wires from the power supply line are connected to the D-MAXE controller with a power supply in the permitted range from 24V to 48V.

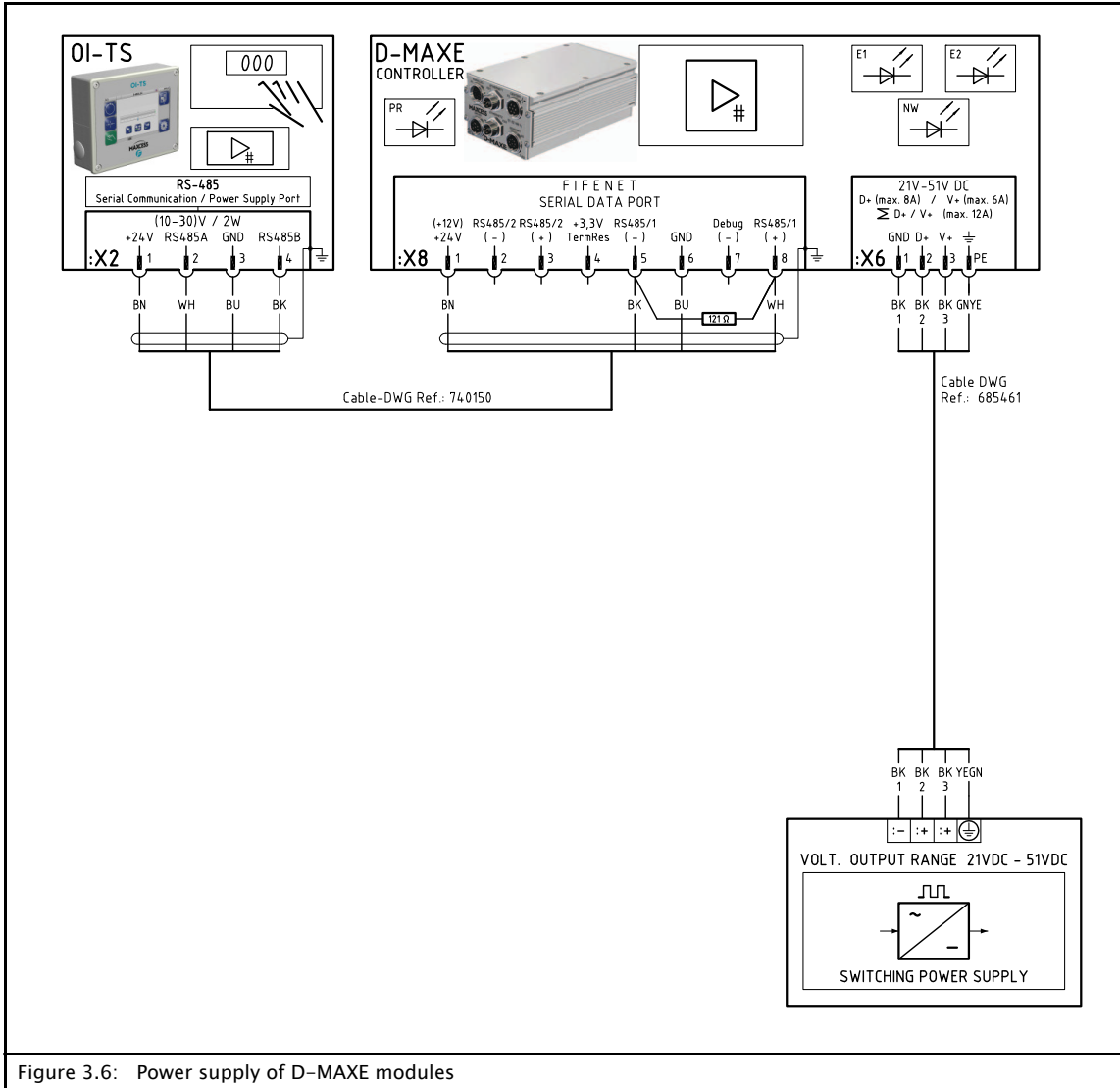

Figure 3.6: Power supply of D-MAXE modules

**Connections on the D-MAXE 1 Controller**

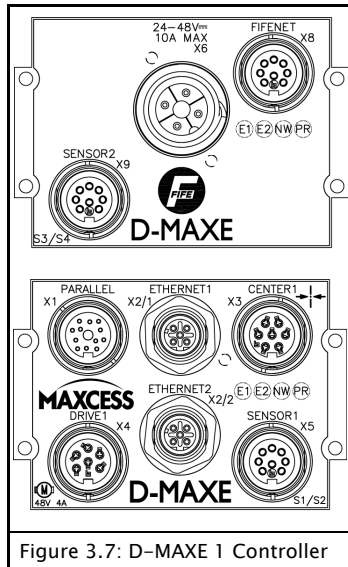

Figure 3.7: D-MAXE 1 Controller

Connection	Designation
X1	Parallel inputs/outputs
X2/1	Ethernet
X2/2	Ethernet
X3	Servo-center transducer 1/Encoder 1
X4	Drive 1
X5	Sensor 1 (S1 / S2)
X6	Power supply voltage
X8	FifeNet/ OI-TS
X9	Sensor 2 (S3 / S4)

For technical details and additional information, please consult Section [11 Technical Data](#).

**Connections on the D-MAXE 2 Controller**

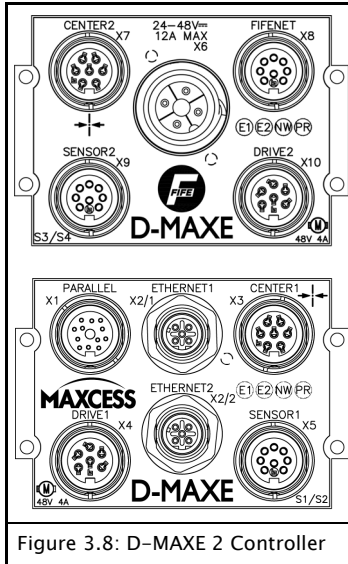

Figure 3.8: D-MAXE 2 Controller

Connection	Designation
X1	Parallel inputs/outputs
X2/1	Ethernet
X2/2	Ethernet
X3	Servo-center transducer 1/Encoder 1
X4	Drive 1
X5	Sensor 1 (S1 / S2)
X6	Power supply voltage
X7	Servo-center transducer 2/Encoder 2
X8	FifeNet/ OI-TS
X9	Sensor 2 (S3 / S4)
X10	Drive 2

For technical details and additional information, please consult Section [11 Technical Data](#).

**LEDs on the D-MAXE  
Controller**

LED	Status	Indicates
E1 (X2/1)	Off	No Ethernet connection
	Green or Green flashing	Ethernet connection detected
	Yellow	Either a 10mbps connection or a half-duplex connection is recognized
E2 (Ξ2/2)	Off	No Ethernet connection
	Green or Green flashing	Ethernet connection detected
	Yellow	Either a 10 mbps connection or a half-duplex connection is recognized
NW	Off	No external device is connected to connection X8
	Green	External device recognized at connection X8 (e.g. an operator interface OI-TS)
PR	Off	No power supply
	Red	Power supply voltage too low, internal voltage outside tolerance or internal temperature too high
	Green	Power supply and temperature OK
	Yellow	No motor voltage

Additional information about error messages that are displayed may be found in Section [Troubleshooting, page 10-1](#).



## 4 OPERATOR INTERFACE OI-TS

### OI-TS description

The OI-TS operator interface has a touch screen.



#### CAUTION:

Danger of damaging the touch screen with pointed and/or hard objects (such as pens or screwdrivers).

⇒ The touch screen must only be operated with a finger or suitable touch screen stylus.



#### CAUTION:

Danger of the touch screen being operated accidentally by falling objects.

⇒ The operator interface must be protected against falling objects.

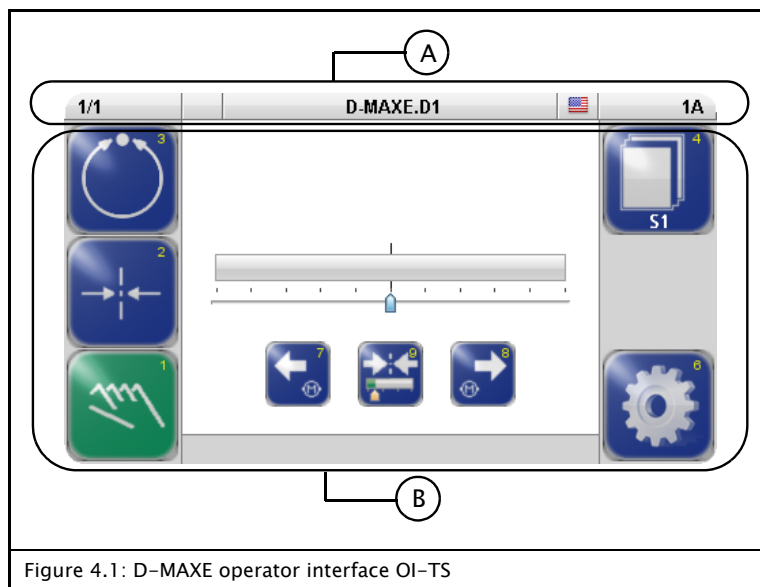

Figure 4.1: D-MAXE operator interface OI-TS

#### A Header

- See [Header, page 4-3](#)

#### B Control area

- Contains all the buttons and displays needed to operate the D-MAXE system
- Changes depending on the menu selected (user level, menu level -> see [Operating the Controller, page 5-1](#))



**Buttons and Displays**



The entry in a menu is accepted



The entry in a menu is rejected



Return to the previous menu level



or



Switch between the pages of a menu



or



Buttons represented in colors can be operated in the current operation state.  
Buttons represented completely in gray cannot be operated in the current operation state.



Fields filled in with white show information and cannot be operated.

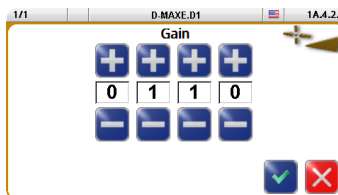

To enter numbers, set the desired value with the + and - buttons.

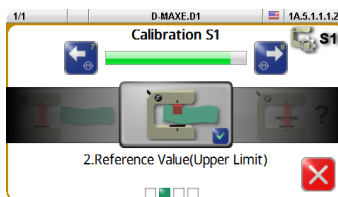



Sequences are a defined succession of menus to be processed by the user step by step.  
The next step can be reached by pressing the button in the middle of the display.

---

## Header

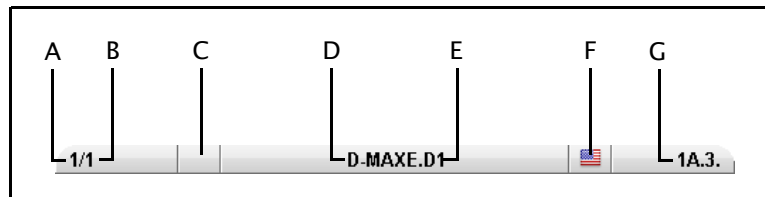
The header contains complete information about the D-MAXE system. It is always available in this form.



- A Shows the currently selected hardware e.g. a D-MAXE Controller
- B Shows the currently selected device of the D-MAXE system if it is present in the D-MAXE system:
  - 1 – Drive 1,
  - 2 – Drive 2,
  - 3 – Customer-specific system menu CM
  - 5 – Gateway
  - 7 – SE-46 Line Sensor
  - 8 – SE-45 Ultrasonic Sensor
  - 9 – DAC-005 Diode Line Camera
-  C no connection
- D Shows the name of the currently selected hardware e.g. D-MAXE Controller (can be edited, see [Device Names, page 7-22](#))
- E Shows the name of the selected device (can be edited, see [Device Names, page 7-22](#))
- F Language selection
- G Menu identification  
Each menu has its own identification. This makes it possible to retrace every step in the control tree of the D-MAXE system precisely.

**Select operator interface**

- Touch the header

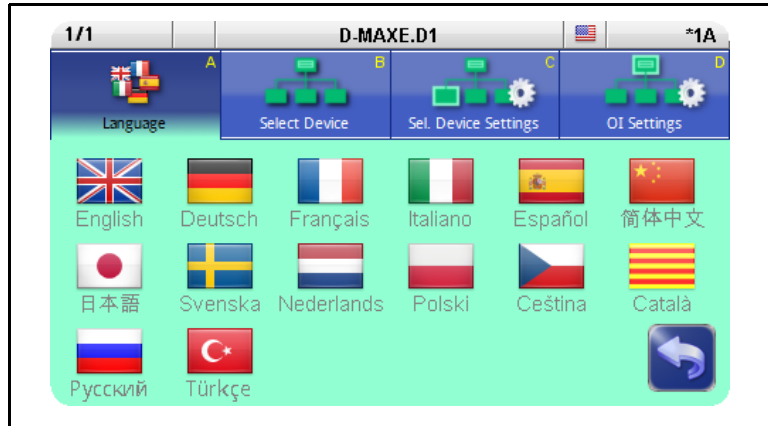

**A Language**



Select the language for menu labels

**B Select Device**

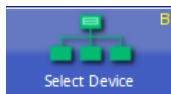

In the list of devices select the one you want to operate with the OI-TS

**C Select Device Settings**



Set up the parameters of the selected device for the display

**Flip horizontally**



Display not mirrored

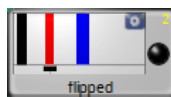

Parts of the display are mirrored, for example the bar graph or the Right and Left buttons

**D OI Settings**



Set up the parameters of the OI-TS

**Labels** This screen contains the details on the nameplate which is affixed to the OI-TS operator interface.

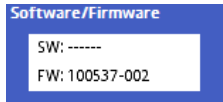

- Software number
- Firmware number

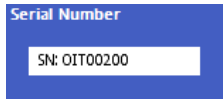

- Serial number

**Settings**



- Change between the US and British flags for display



- Calibration of the touch screen  
Calibration is required if the activity of the buttons is not synchronous with the location that is displayed. The user is prompted to touch the screen at two points. Use of a suitable touch screen stylus is recommended to improve the accuracy of the calibration.

**Debugging**



Other than the *Touch Test*, this collection of functions is intended for Service and is not relevant for the operator.

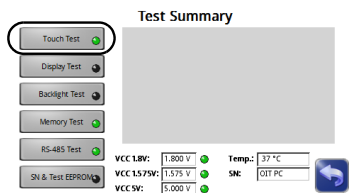

**Touch Test**

This test can be performed if no actions or incorrect actions are performed on the OI-TS operator interface.

→ see *D-MAXE operator interface OI-TS, page 10-3*

## 5 OPERATING THE CONTROLLER

### User level

All the functions required for normal operation of the D-MAX systems are available on the user level.

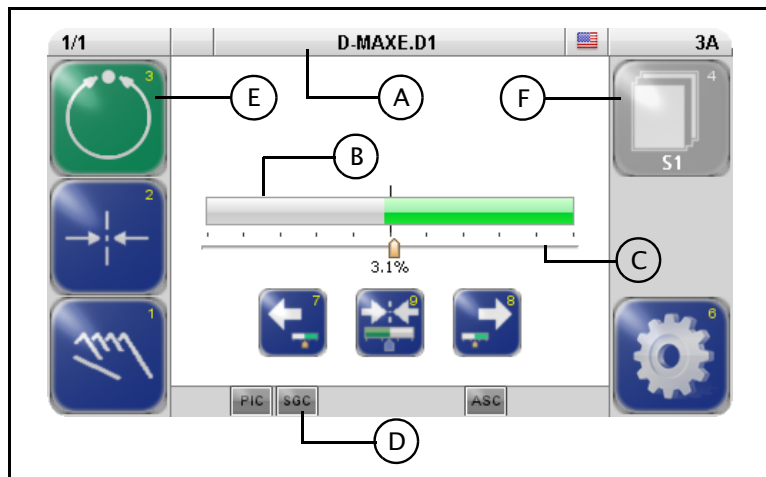

### Buttons

- 1 select operating mode „Manual“
- 2 select operating mode „Servo-center“
- 3 select operating mode „Automatic“
- 4 Select available jobs (controller types)
- 5 Available for special applications only
- 6 Press and release: Open the *Job* menu for the current job  
Press and hold: Open the *Setup* menu
- 7 and 8 „Automatic“ operating mode: Move the guide point in the sensor field of view  
„Manual“ and „Servo-center“ operating mode: move actuator
- 9 „Automatic“ operating mode: resetting the guide point  
„Manual“ operating mode: set the guide point
- A Header: select devices/actuators

### Legend

- A Header: Information about the D-MAX system
- B Bar graph  
„Automatic“ and „Manual“ operating mode: signal level of the active sensor  
„Servo-center“ operating mode: signal level of the servo-center transducer

- C Guide point display  
Operating mode „Automatic“ and „Manual“: Guide point offset of the active sensor
- D Status line  
Symbols see [Appendix B – Symbols, page 13–1](#)
- E Green marked button  
Identifies the currently selected operation mode
- F Gray marked button:  
This button has no function in the current system status.

### Select devices/actuators

The OI-TS can be used to operate various devices present in the network (D-MAX controllers and their actuators, any system menus or gateways that are present).



- Touch the header and select menu [B Select Device](#)
- Select the device you want to operate with the OI-TS

### Select operating modes



#### Automatic

The web course is guided by an actuator based on sensor information.  
The bar graph represents the position of the material web in the sensor's field of view.



#### Servo-center

The actuator is moved to the mechanical center position depending on the servo-center transducer. Then the control rollers are aligned parallel to the rollers of the customer system.  
The bar graph indicates the current position of the actuator in relation to the servo-center transducer.



#### Manual

There is no guiding of the web course. The settings of the D-MAX system can be changed.  
The bar graph represents the position of the material web in the sensor's field of view.

## Select jobs



Jobs are types of controllers that, in principle, are available in a D-MAX system.

From the large number of possible controller types, customer-specific programming selects the controller types that have the required functionality for the customer's application and makes them available (see [Jobs, page 11-5](#)).

Existing jobs can be [1y.6.2 Jobs, page 7-19](#) limited or extended in the menu.

It is only possible to select another job on the user level in "Manual" and "Servo-center" operation modes.

## Shift guide point



Note:

This parameter can also be set with menu *Job* (see page [7-3](#)).

### „Automatic“ operating mode

The guide point can be shifted within the sensor's field of view during ongoing operation.



Note:

This is only possible if the parameter has been set up appropriately in menu [1y.6.3.1 Jog Enable, page 7-19](#).

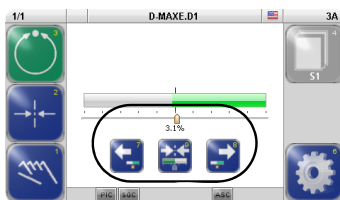

- Move the guide point to the desired position using the arrow buttons 7 and 8

A cursor appears in the display at the location to which the guide point was moved, together with a numeric entry.

- Press button 9 to reset the guide point

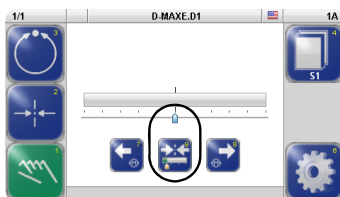

### "Manual" operating mode

- Press on button 9 to set the guide point alternately
  - to 0 or
  - pre-set it, so that it takes the value of the selected sensor and enables a bounce-free transfer to 'Automatic' mode.

---

## Moving the actuator

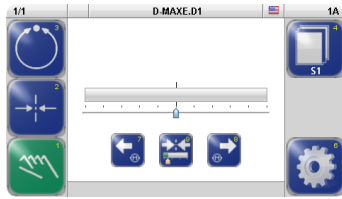

The actuator can be moved in "Manual" operation mode.

- Move the actuator to the desired position with arrow buttons 7 and 8

---

## Menu level

The parameters of the D-MAX system can be set for the relevant customer application in the menu level. They have been combined to form the following menu groups:

- *Job* menus (page [5-5](#))
- *Servo-center* menus (page [5-6](#))
- *Setup* menus (page [5-7](#))

For an explanation of the menus for the individual parameters see section [Menus, page 7-1](#).



**Job menu**

Precondition:  
"Manual" or "Automatic" operation mode is selected

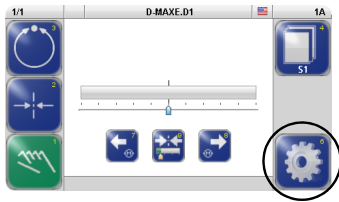

- Press and release button 6 on the user level  
Menus are available for setting up the parameters of the selected job.

Not all menus are available in the "Automatic" operation mode.

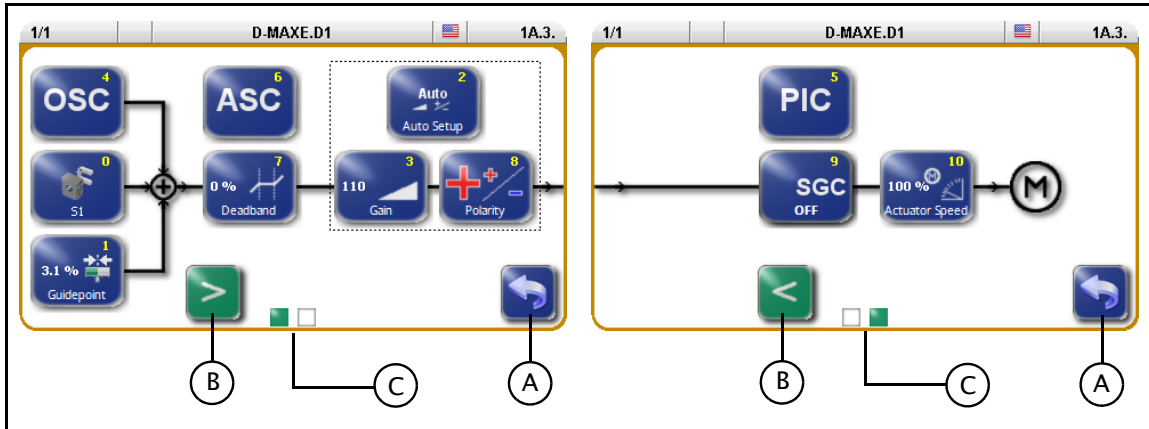

**Buttons**

- 0 Calibrate sensor
- 1 Guidepoint
- 2 Auto Setup
- 3 Gain
- 4 OSC (oscillator)
- 5 PIC
- 6 ASC (Automatic Signal Control)
- 7 Deadband
- 8 Polarity
- 9 SGC (Speed Gain Control)
- 10 Actuator Speed

**Legend**

- A Exit menu
- B Change page
- C Page display

### Servo-Center menu

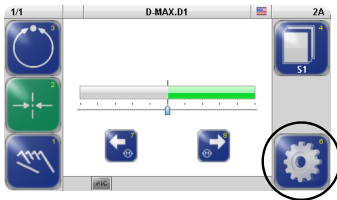

Precondition:  
"Servo-Center" operation mode is selected

- Press and release button 6 on the user level  
Menus are available for setting up the parameters of the servo-center transducer.

Not all menus are available in the "Servo-Center" operation mode.

The *Polarity* menu is only available if the *Setup* menu is selected in the "Manual" operation mode and then 4 *Servo-Center* is selected.

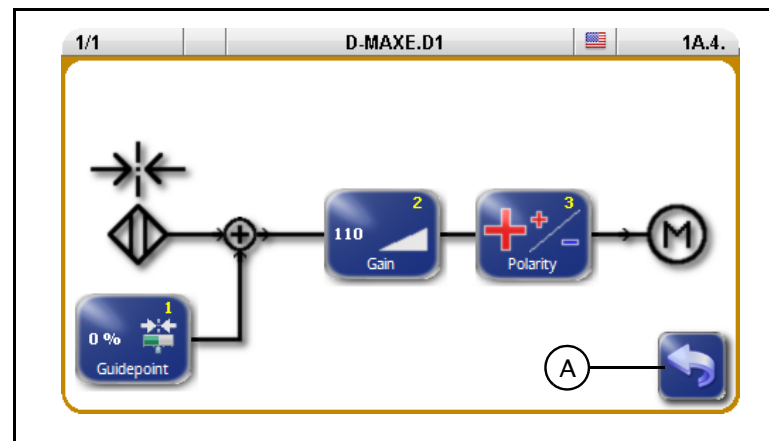

#### Buttons

- 1 Guidepoint
- 2 Gain
- 3 Polarity

#### Legend

- A Exit menu

## Setup Menu

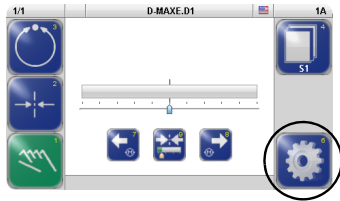

- Press button 6 in the operator level for *more than 2sec* Menus are available for setting up the parameters of the selected job or D-MAX system.

Not all menus are available in the "Servo-center" and "Automatic" operation modes or in restricted local operation. Only the menus that can be operated in the current system status are displayed.

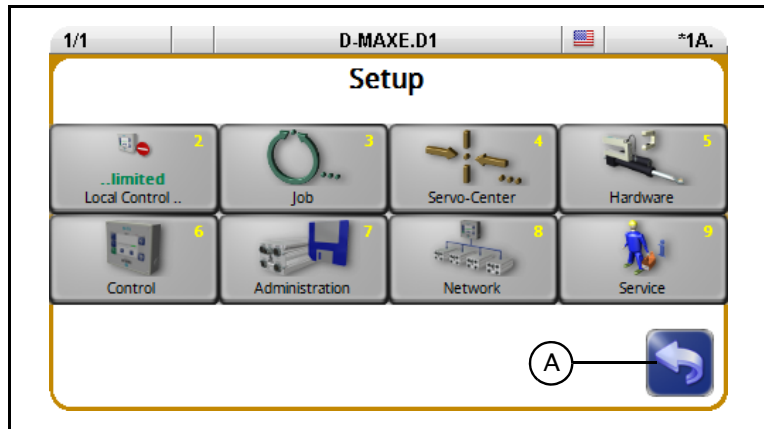

## Buttons

- 2 Local Control
- 3 Job  
Switch to the Job menu (see page 5-5)
- 4 Servo-Center  
Switch to the Servo-center transducer menu (see page 5-6)
- 5 Hardware
  - 1 Sensors
  - 2 Actuator
  - 3 Digital Inputs
  - 4 Digital Outputs
- 6 Control
  - 1 Modes
  - 2 Jobs
  - 3 Left/Right buttons
  - 4 Local Control
  - 5 Unit
  - 6 Hardlock
- 7 Administration
  - Labels
  - Serial Number
  - Backup and Restore
  - Device Names
- 8 Network
  - Maxnet Settings and Distributed System
  - Customer Settings

- 9 Service
  - 1 Measurements
  - 2 Simulate Outputs

Details regarding the menus are explained in section [Menus](#), [page 7-1](#) .

**Legend**

- A Exit menu

## 6 COMMISSIONING

### Before commissioning

The following assembly and electrical connection tasks must be performed before commissioning:

- The modules of the D-MAXE system must be assembled properly.
- The modules of the D-MAXE system must be properly connected to the power supply and integrated into the 'EMERGENCY STOP' circuit of the customer's system.
- The sensors and actuators must be properly connected to the D-MAXE system.
- It is also important to become familiar with the basic operation of the operator interface OI-TS.

### Commissioning

Once all assembly and connection tasks have been checked and are in proper condition, the D-MAXE system can be placed in operation.



#### WARNING:

Before commissioning, ensure that:

- ⇒ Commissioning of the D-MAXE system is performed while the web is stopped.
- ⇒ No one is in the danger zone of the moving parts.



#### Note:

The D-MAXE system has been preset to the customer application and checked before it leaves the factory. However, this does not apply to individual or replacement part deliveries.



#### WARNING:

There is a risk of crushing and cutting injuries on the web material itself and/or due to the motion of the web.



- ⇒ Do not grasp moving parts (rollers, web, etc.) or anything close to them during commissioning.

- ⇒ Do not touch the edges of the material web.

To commission the D-MAXE system, make the basic settings described in the following steps.



Note:

If the system documentation contains "D-MAXE Supplementary Operating Instructions" with a chapter on Commissioning, the commissioning sequence given there must be followed for the specific application.

**1. Turn on the electrical power**

When the system is turned on, the last operating mode to be selected is active.

**2. Select the language**

It may be necessary to change the language for menu guidance on the operator interface.

→ see menu [A Language, page 4-4](#)

**3. Select drive (device)**

→ see menu [B Select Device, page 4-4](#)



Note:

Each drive must be set separately.

**4. Take over *Local Control***

If the parameter *Local Control* is set to "...limited", it needs to be set to "...taken over".

→ See menu [2 Local Control, page 7-2](#)



**5. Select Manual mode**

Switch the D-MAXE system into Manual mode with the button 1 on the operator interface.

There is no guiding of the web course in Manual mode. The D-MAXE System control parameter can now be configured.

**6. Set the sensor type**

Check and set the type of the connected sensor(s).

→ see [1y.5.1.1.2 Type, page 7-13](#)

**7. Calibrate sensor(s)**

Calibrate the connected sensor/sensors.

→ see [1y.5.1.1.1 Calibration, page 7-12](#)

**8. Calibrate *LineSpeed***

If the *LineSpeed* parameter is being used, this parameter must be calibrated.

→ see menu [1y.5.1.5 Line Speed, page 7-14](#)

9. Set the *Polarity* for the Servo–Center operation mode  
→ see menu [1y.4.3 Polarity, page 7–10](#)

10. Set the *Gain* for the Servo–Center operation mode  
→ see menu [1y.4.2 Gain, page 7–10](#)

11. Calibrate the *Encoder/motor encoder*  
If an encoder or motor encoder is used, it must be calibrated.  
→ see menu [1y.5.1...1 Calibration, page 7–15](#)



12. Select job  
Select the job with the parameters to set with button 4.  
→ see [Select jobs, page 5–3](#)

13. Turn off the *OSC/PIC*  
If the optional parameters 'OSC' or 'PIC' are found in the selected job, these parameters must first be switched to the OFF state (see also the Operating Instructions "D–MAXE/OSC" or "D–MAXE/PIC").

14. Set *Polarity*  
→ see menu [1y.3.y8 Polarity, page 7–8](#)

15. Set *Gain*  
→ see menu [1y.3.y3 Gain, page 7–4](#)

16. Turn on the *OSC/PIC*  
If the optional parameters 'OSC' or 'PIC' are present, these parameters must be correctly set. To do this, perform the commissioning sequence as described in the relevant Operating Instructions.

17. Set up additional jobs  
Steps 12 to 16 must be performed for each job.

18. Limit *Local Control*  
If the parameter *Local operation* has been set to "...taken over" (see Item 4), it now needs to be re–set to "...limited".  
→ See menu [2 Local Control, page 7–2](#)

## 7 MENUS

### Notes

This section is a description of menus that are needed for commissioning and to make other settings in the D-MAXE system.

### Menu identification

Each menu has its own identification. This makes it possible to retrace every step in the control tree of the D-MAXE system precisely.

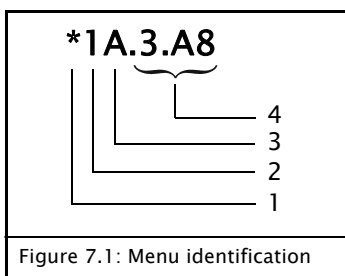

#### 1. Local Control

Identifies the status of local operation

→ see [2 Local Control, page 7-2](#)

#### 2. Operating mode

1 – Manual

2 – Servo-Center

3 – Automatic

#### 3. Job

Identifies the currently selected job

→ see [Jobs, page 11-5](#)

#### 4. Menu levels

Identifies the position of a menu within the menu structure of the D-MAXE system

### Conventions

The following conventions apply to the menus described here:

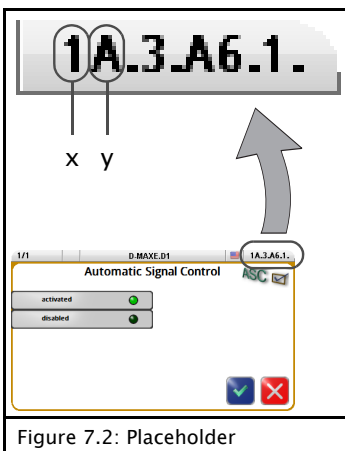

#### x

Placeholder "x" is the operation mode currently selected on the drive (in the example x = 1).



#### Note:

The menus in the D-MAXE system are described in "Manual" mode (x = 1), since that is the only mode in which all menus can be reached.

#### y

Placeholder "y" is the currently selected job on the drive (in the example y = A).

This place in the menu identification changes depending on the job selected by the customer.

→ see [Jobs, page 11-5](#)



2 Local Control

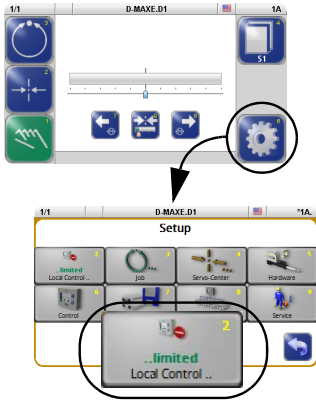

The *Local Control* menu can be used to block control signals which are a hindrance during initial operation or an error search. Control signals can be:

- a parallel interface (connector X1)
- an application in a "distributed system" that administers various components at the same time  
→ see menu [1y.8.8 Distributed System, page 7-24](#)
- a Gateway to external fieldbus systems



**Note:**  
This menu is only available if control signals are at hand from the aforementioned sources.

An \* (asterisk) appears before the menu identification to indicate that local operation is limited. The menu identification is in the header at the far right.



\* Local Control was taken over.



(\*) Other control signals are active. However, these control signals are blocked when local control is applied.



If there is no \* against the menu identification, no other control signals are available.

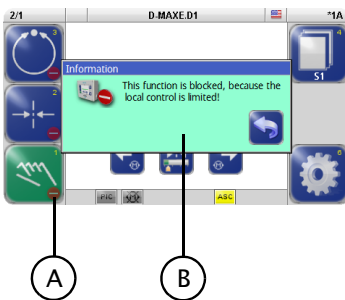

A Buttons which are blocked by an active control signal are marked.

B Information appears if a user attempts to operate a locked button.

## 1y.3 Job

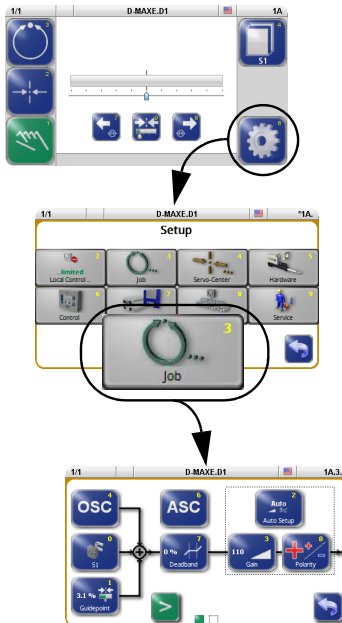

This section is a description of menus that are used to set up the parameters of a job. A similar set of parameters is available for each job in the system. The settings of this job apply to "Automatic" mode.

However, the number of available parameters that can be set for a job depends on customer-specific programming of the D-MAXE system.

Each job is marked with a capital letter on the right-hand side in the menu identification in the header.

### "Manual" mode:

- All buttons are available.

### "Automatic" mode:

- Only selected buttons are available.

### "Servo-Center" mode:

- These parameters cannot be set.

### Precondition

- the correct device / the correct drive is selected  
*Check:* Check the display in the header
- the correct job is selected  
*Check:* Check display on button 4

### 1y.3.y0 Calibrate sensors



The menu for calibrating the sensor that is used can be called directly.

→ see [1y.5.1.1.1 Calibration, page 7-12](#)

### 1y.3.y1 Guidepoint



The guidepoint of the selected job can be adjusted for the corresponding drive with the *Guidepoint* menu.



Note:

The *Offset* parameter can also be set directly with buttons 7 and 8 in "Automatic" operation mode on the user level.

→ see [Shift guide point, page 5-3](#).

**1y.3.y2 Auto Setup**



The *Auto Setup* menu is used to calibrate parameters Gain (page 7-4) and Polarity (page 7-8) automatically for "Automatic" mode of the selected drive.



**WARNING:**

The drive moves during automatic setup.

⇒ There is a danger of body parts being crushed against the actuator.



**Note:**

The sensors must be calibrated before the automatic setup.

**1y.3.y3 Gain**



You can use the *Gain* menu to adjust the guide sensitivity of the selected drive.

**1y.3.y4 OSC**



You can use the *OSC* menu to select the optional oscillator 'OSC' of the D-MAXE system.

The oscillator 'OSC' is only present in a job of the D-MAXE system if the software has been programmed accordingly. Commissioning and operation are described in separate operating instructions.

**1y.3.y5 PIC**



The *PIC* menu allows the user to control the web course even if there is no direct feedback available from the drive to the sensor.

The 'PIC' controller is only present in a job of the D-MAXE system if the software has been programmed accordingly. Commissioning and operation are described in separate operating instructions.

**1y.3.y6 ASC**



You can use the *ASC* menu (Automatic Signal Control) to

- activate and deactivate the ASC parameter and
- set up ASC threshold 1 or 2. These thresholds restrict the outward visual range of the sensor.

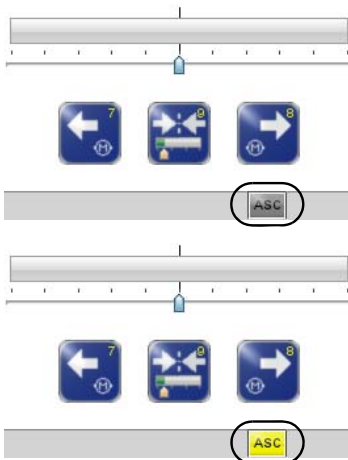
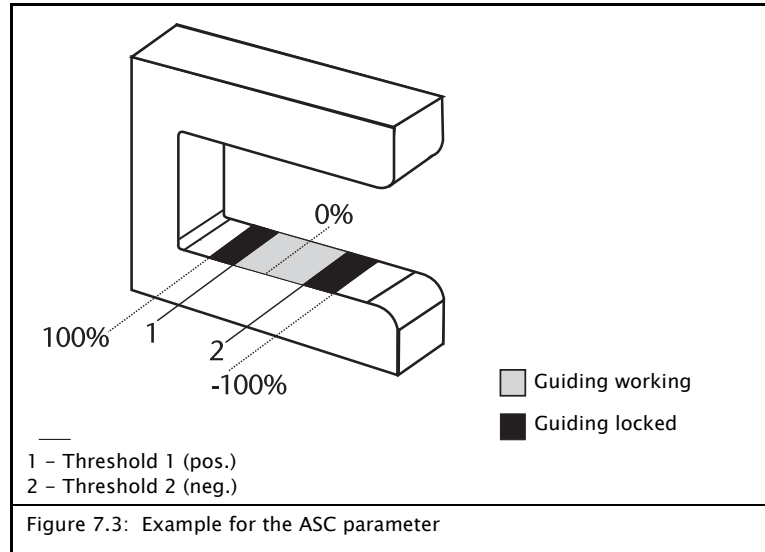

If the D-MAXE system is in "Automatic" mode and the ASC parameter is activated, the web is guided as long as it is within the restricted field of view of the sensor. This is indicated by the gray "ASC" icon in the status line.

If the web leaves the limited field of view of the sensor, guiding is blocked. This is indicated by the yellow "ASC" icon in the status line.



### 1y.3.y6.1 Turn ASC on or off

The ASC parameter is activated or disabled.



### 1y.3.y6.2 Enter the limit value 1

The value that is entered must be positive.  
 Standard value = 90%



### 1y.3.y6.3 Enter the limit value 2

The value that is entered must be negative.  
 Standard value = -90%

**1y.3.y7 Deadband**



The *Deadband* menu is used to define a range around the guide point within the sensor field of view in which guiding is reduced or is not active at all in the "Automatic" operation mode.



**Note:**  
Available in the form described here beginning with firmware version 016b of the D-MAXE controller

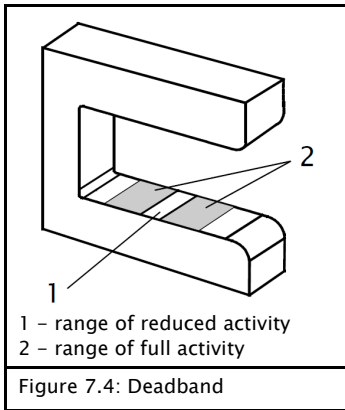

- If the web edge is in the range of reduced activity (1), there is no guiding or only accordingly reduced guiding.
- If the web edge is outside the range of reduced activity (2), guiding is with full activity.

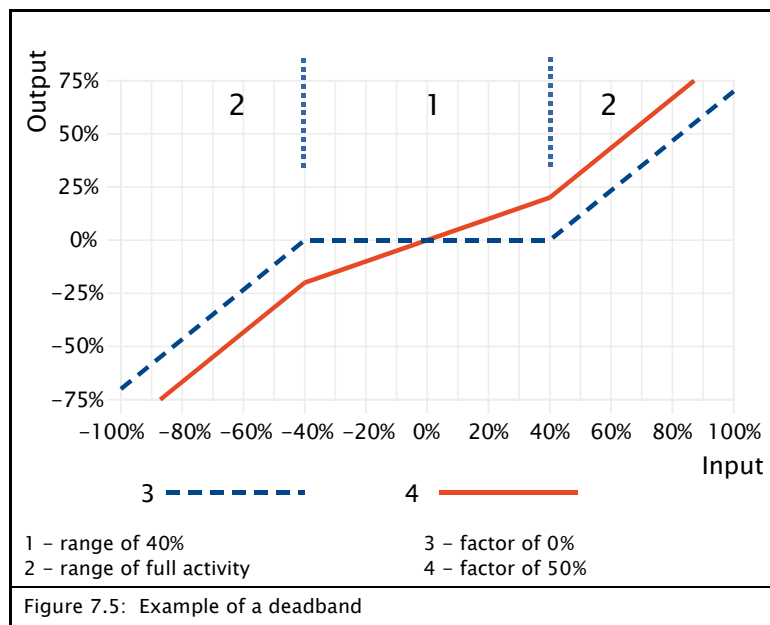

The following two parameters must be set for the deadband.

**1y.3.y7.1 Range**

- A value of 0% means that there is no range with reduced activity. This is also the default value for the range.
- A value of 50% means that half the sensor field of view has been defined as a range with reduced activity.

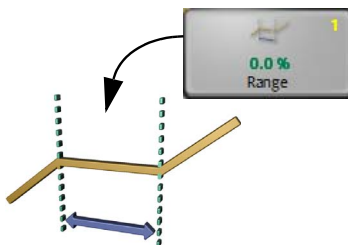

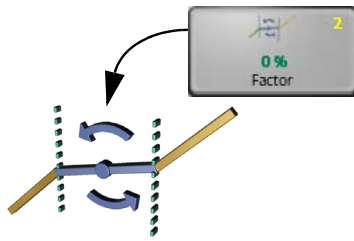

### 1y.3.y7.2 Factor

- A factor of 0% means that there is no activity in range 1. This is also the default value for the factor.
- A factor of 50% means that the activity in range 1 is half as great as in the active range 2.

### Web guiding processes with unfavorable sensor position

Web guiding processes in which the sensor cannot be arranged as it usually is in the first half of the control roller output range develop an extremely unsettled and unstable guiding behavior.

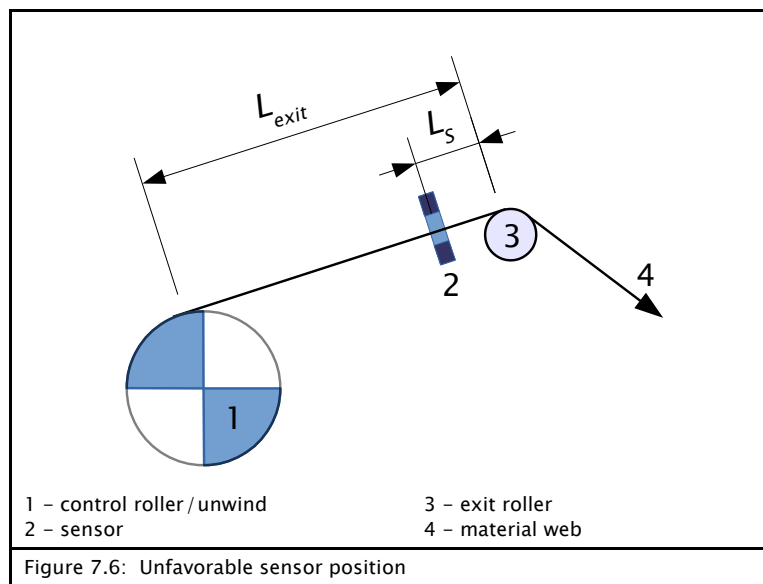

Figure 7.6: Unfavorable sensor position

### Preconditions:

This problem can be handled with the *Deadband* parameter under the following conditions:

- Exit length  $L_{exit}$  of web guiding is equal to or greater than about 1.5 times the maximum web width  $B_{max}$ .

$$L_{exit} \geq 1.5 \cdot B_{max}$$

- The distance  $L_s$  from the sensor to the exit roller is equal to or greater than about 10% of the exit length  $L_{exit}$ .

$$L_s \geq 10\% \cdot L_{exit}$$

- Other than a few large web offsets, there are only slow web offsets to compensate for.
- The material web that is used naturally runs evenly and smoothly.

**Settings:**



- Set the range of reduced activity to 0%



- Adjust the guiding sensitivity of the drive (page 7-4) aggressively  
It is no problem if the drive overreacts somewhat. To reach the full adjusted speed, a value of over 100 must be reached if a sensor with a field of view of about 18 mm is used (for example SE-42). Sensors with a larger field of view require higher setting values.



- Enlarge the area of reduced activity until the drive is responding almost smoothly while the material web is running.

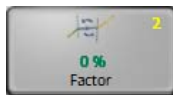

- Increase the factor to strike a good compromise between compensated drive movements and guiding accuracy. The optimum value for the factor is usually between 10% and 50%.

**1y.3.y8 Polarity**



The *Polarity* menu is used to set the guiding direction of the selected drive for "Automatic" mode.

**1y.3.y9 Speed Gain Control**



The *Speed Gain Control* menu is used to determine whether web speed will affect how guiding is performed.

The *Speed Gain Control* menu is only present in a job of the D-MAXE system if the software has been programmed accordingly.

The information about web speed is fed in through either a digital network or an analog signal (see menu [1y.5.1.5 Line Speed, page 7-14](#)).



If the *Speed Gain Control* parameter is activated, guiding depends on web speed. This is indicated by the gray “SGC” icon in the display.

This icon flashes when the web speed is too low and no guiding is being performed.

### 1y.3.y10 Actuator Speed



You can use the *Actuator Speed* menu to set the maximum speed of the motor on the selected drive.



## 1y.4 Servo-Center

This section describes menus that are used to set up the properties for "Servo-Center" mode.

The availability of the *Guidepoint* parameter depends on the customer-specific programming of the D-MAXE system.

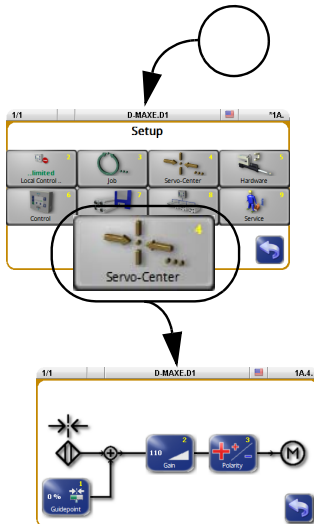

### "Manual" mode:

- All buttons are available.

### "Servo-Center" mode:

- Only selected buttons are available.

### "Automatic" mode:

- These buttons cannot be set.

### 1y.4.1 Guidepoint



The optional *Guidepoint* menu is used to adjust the servo-center transducer guide point for the selected drive to requirements in the client's system.

If this information is not required for the relevant customer application, the parameter should be set to the default value=0. If it is necessary to enter another value, the process is described in "Supplementary Operating Instructions" and is included in the system documentation.

### 1y.4.2 Gain



The *Gain* menu is used to set the guide sensitivity of the servo-center transducer for the "Servo-Center" operation mode on the selected drive.

### 1y.4.3 Polarity



The *Polarity* menu is used to set the guide direction of the servo-center transducer for the "Servo-Center" operation mode on the selected drive.

## 1y.5 Hardware

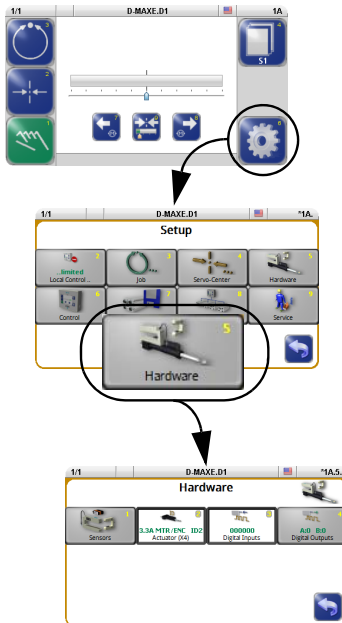

This section contains a description of menus that can be used to view and set up the properties of the connected input and output devices.

### "Manual" mode:

- All buttons are available.

### "Servo-Center" mode:

- All buttons are available.

### "Automatic" mode:

- Only selected buttons are available.

### 1y.5.1 Sensors



The analog sensors present in the system must be calibrated. Each sensor in the system must be calibrated on the controller to which the sensor is connected.

#### 1y.5.1.1 Sensor S1 X5/1

...

#### 1y.5.1.4 Sensor S4 X9/2



The sensors connected to connections S1 X5/1 to S4 X9/2 can be calibrated.



#### Note:

It is possible that special sensors are used in the customer's system, for example a capacitive sensor or a camera. Sensors of this type cannot be calibrated with the procedure described here. The information required for a calibration is available in a set of special operating instructions for the sensor or in "Supplementary Operating Instructions" in the system documentation.



#### Note:

There can be menus for all sensor connections even if not all the connections are assigned. Therefore the connections that are used must be correctly selected. Additional information may be found in the system diagram of the system documentation.



**1y.5.1.1.1 Calibration**

The *Calibration* menu is used to adapt the sensors to the properties of the web material.



**WARNING:**

To calibrate a sensor, it may be necessary to move the material web inside the sensor's field of view by hand. There is a risk of being cut by the web and crushed against the actuator.



⇒ Do not touch the edges of the material web.

⇒ Perform the calibration operation only when the machine has been stopped and secured to prevent restart.



**Note:**

It is essential to follow the instructions for installation of the sensor in the corresponding Operating Instructions.

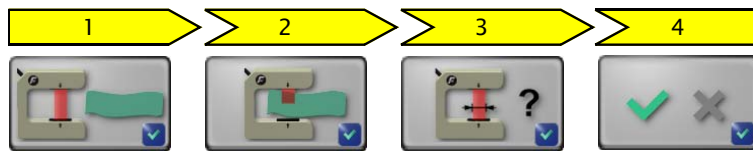

1. The reference value for the uncovered sensor must be determined. To do this, remove the material web completely from the sensor's field of view.
2. The reference value for the covered sensor must be determined. To do this, the sensor's field of view must be completely covered by the material web.
3. Optional:  
The connected sensor's field of view is entered in mm or inch (see menu [1y.6.5 Unit, page 7-20](#)).  
You will find more details about the field of vision in the 'Supplementary operating instructions' or in the overview in the system documentation.  
If the value is not known, the system can accept the suggested value.
4. The result of the calibration is displayed and can be saved.



**Note:**

If an error occurs during calibration, the error will appear in the menu and calibration must be repeated.



### 1y.5.1.1.2 Type

The *Type* menu specifies which sensor type is connected in the D-MAXE system in use. Menu can be adapted to the sensor type and the analogue entries are set.

Type	Sensor type	Analogue sensor inputs	Effect on operation
SE-46	SE-46 line sensor	Set to 0-10 mA	If it is detected that the required parameters are set incorrectly, a message box appears when the Job menu opens with the option of setting those parameters correctly.
SE-26	SE-26 line sensor	No change	A special sequence for calibration is provided in item <a href="#">1y.3.y0 Calibrate sensors, page 7-3</a> of the Job menu  Note: The <a href="#">1y.5.1.1.1 Calibration</a> menu is not changed.
---	All other sensors	No change	No special effects



### 1y.5.1.1.3 Field of View

You can use the menu to scale the field of view of the connected sensor.

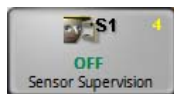

### 1y.5.1.1.4 Sensor Supervision

You can use the *Sensor Supervision* menu to turn this parameter on and off.



#### Note:

This parameter's functions are only of use if the sensor features a output signal of 4 .. 20mA.

The parameter is used to detect a faulty connection between the D-MAXE Controller and a connected sensor. This parameter can only be evaluated if corresponding customer-specific programming is present.



**1y.5.1.1.5 Current Range**

The *Current Range* menu shows in which range the sensor input on the D-MAXE controller was configured according to the last valid sensor calibration.

**1y.5.1.5 Line Speed**

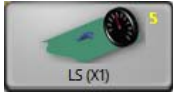

The *Line Speed* menu is used to calibrate the analog Line Speed signal. This signal can be used for example to influence the guiding sensitivity of the drive (see menu *1y.3.y9 Speed Gain Control*, page 7-8)..



1. The reference value for the minimum web speed must be determined.  
To do this, the material web with the relevant application must be running at minimum web speed in the customer system.
2. The reference value for the maximum web speed must be determined.  
To do this, the material web with the relevant application must be running at maximum web speed in the customer system.
3. If the result determined from the reference values for web speed-dependent guiding can be used, the display shows "Successful!".



**Note:**  
If the result for guiding is too low, an error appears in the menu and the calibration must be repeated.

**1y.5.1.7 Encoder**

...

**1y.5.1.8 Motor Encoder**



An incremental position transducer (encoder/motor encoder) can be connected to each drive on the D-MAXE to record positions. This makes position monitoring and evaluation possible.

In most applications, the encoder is used together with a sensor positioning system.



Note:

Generally the encoder is already preset when it ships from the factory. Therefore a resetting is required only when replacement parts are installed.



Note:

The menus for the motor encoder (menu 8) are not present unless a corresponding motor is present on the selected drive.



### 1y.5.1...1 Calibration

You can use the *Calibration* menu to calibrate a connected incremental position transducer (encoder/motor encoder) for the selected drive. The servo-center transducer assigned to this drive determines the reference position of the travel path.

---

#### WARNING:

The selected drive must be moved to calibrate the encoder.



There is a risk of being cut by the web and crushed against the actuator.

⇒ Do not touch the edges of the material web.



⇒ Perform the calibration operation only when the machine has been stopped and secured to prevent restart.



#### CAUTION:

Changing the encoder limits may result in danger of crushing or could damage the mechanical stops.

---



Note:

The servo center transducer must be positioned within the restricted travel path before it is possible to approach the servo-center position in "Servo-Center" mode.

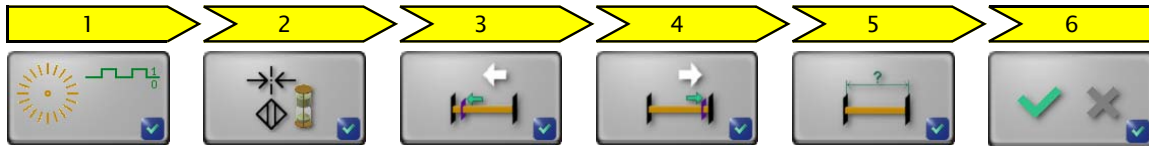

1. The calibration sequence is started.



**WARNING:**

The selected drive moves.

⇒ Do not grasp moving parts or anything close to them.

2. The drive is automatically moved to the servo-center position.  
Once the servo-center position is reached, the sequence automatically continues with step 3.



**Note:**

If the center position is not reached, the servo-center transducer itself must first be checked. The parameters of the [1y.4 Servo-Center, page 7-10](#) must then be checked and reset, if required.

- 3. The value for the first limit must be determined. To do this move the drive with the arrow buttons to the position of the first limit.
- 4. The value for the opposite limit must be determined. To do this move the drive to the position of the opposite limit.
- 5. The menu displays a recommended distance between the two limits. This value is to be checked and corrected if necessary.
- 6. The calibration of the encoder was successful and the settings can be saved.



**1y.5.1...2 Travel Length**

The *Travel Length* menu is used to correct the calibrated travel path of the encoder.

The measured distance is to be entered into this menu.



**Note:**

The encoder must be calibrated before this parameter can be set



### 1y.5.1...3 Search Reference

You can use the *Search Reference* menu to recover lost thresholds without having to perform a calibration again. Limit values can be lost for example because the encoder was adjusted with the electrical power turned off.



#### WARNING:

The drive moves while the reference search is active.

⇒ The actuator poses a crushing hazard.

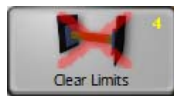

### 1y.5.1...4 Clear Limits

You can use the *Clear Limits* menu to delete limits that are present for the selected encoder.



#### CAUTION:

Deleting the encoder limits may result in additional danger of crushing or could damage the mechanical stops.

### 1y.5.2 Actuator



Shows the motor that is connected to the selected drive (see table on page [17-6](#))

### 1y.5.3 Digital Inputs



Display of the 6 digital inputs

### 1y.5.4 Digital Outputs

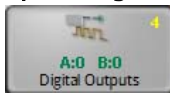

Configuration of the physical properties of digital outputs A and B



1y.5.4.1 Digital Output A

...

1y.5.4.2 Digital Output B

The outputs are automatically set to 'Set' or 'Cleared' depending on the configuration and current operating state.

→ see table *Parallel output matrix, page 11-4*



1y.5.4...1 Delay

A delay time can be defined for the transition from 'Cleared' to 'Set'.



1y.5.4...2 <Set> State

1y.5.4...3 <Cleared> State

To adjust the digital outputs for each of the components connected to them, the physical properties of the relevant state ('Set'/'Cleared') can be defined for each output A or B.

You can select individually for each state between:

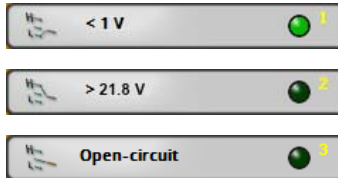

## 1y.6 Control

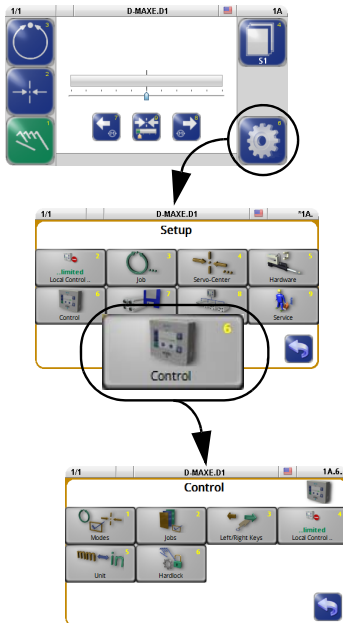

This section includes information about menus that contain basic properties for operating the D-MAXE Controller.

### "Manual" mode:

- All buttons are available.

### "Servo Center" and "Automatic" mode:

- Only the *Local Control* button is available.

### 1y.6.1 Modes

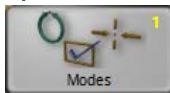

Activate or deactivate the "Automatic" and "Servo-Center" operation modes



#### Note:

"Manual" mode cannot be deactivated.

### 1y.6.2 Jobs



Activate or deactivate jobs

→ see table [Jobs, page 11-5](#)

### 1y.6.3 Left/Right buttons



Define different properties of the Right/Left buttons



#### 1y.6.3.1 Jog Enable

The functions listed here can be allowed or turned off in reference to the individual operation modes.



#### 1y.6.3.2 Jog Direction

The working direction of the buttons is set.



**1y.6.3.3 Jog Speed**

The adjusting speed of the buttons is set.



**1y.6.3.4 Jog Soft Start**

The adjusting speed of the buttons set in menu 1y.6.3.3 is reached after the time indicated here.

**1y.6.4 Local Control**



Apply or restrict *Local operation*

→ see also [2 Local Control, page 7-2](#)

**1y.6.5 Unit**

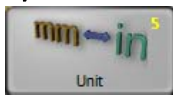

Setting up the desired length unit



Note:

Rounding errors may occur when the unit changes.

**1y.6.6 Hardlock**



The *Hardlock* menu is used to set up three parameters. When the operating mode switches to "Manual" the position of the drive is kept active at that time by these three parameters.

Power is normally turned off to the drive in "Manual" mode. The de-energized drive may be shifted by an external force in the case of unfavorable conditions in the client's system. The drive can be actively maintained in its position in 'Manual' mode to avoid such circumstances.



Note:

This parameter can only be used if an encoder is available for the selected drive.

**1y.6.6.1 Hardlock**



Turn the Hardlock parameter on and off

**1y.6.6.2 Gain**



Set the gain for the Hardlock parameter

**1y.6.6.3 Polarity**



Set the polarity for the Hardlock parameter

## 1y.7 Administration

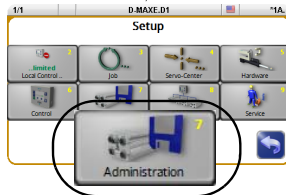
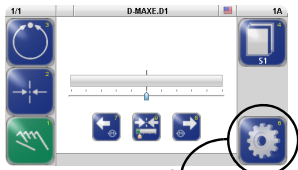

This section includes a list of menus containing information about the D-MAXE Controller. This information is required when ordering replacement parts or for service inquiries.

### "Manual" mode:

- All buttons or input fields are available for use.

### "Servo Center" and "Automatic" mode:

- Only selected buttons or input fields are available for use.

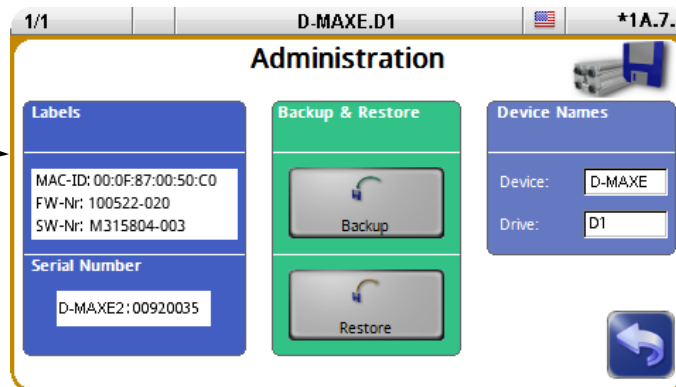

### Labels

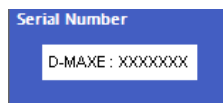
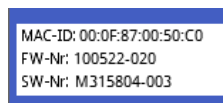

This screen contains the details on the label which is affixed to the D-MAXE Controller housing.

- MAC ID, firmware number and the D-MAXE Controller software number
- D-MAXE Controller serial number

### Backup & Restore



#### Note:

On a D-MAXE 2 Controller, "Manual" operation mode must be selected on both drives.

#### Backup

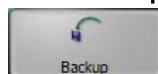

You can use the *Backup* menu to save all current user settings of the D-MAXE Controller to a backup copy in the module.

If a backup has already been saved, the old values will be overwritten by the current ones.



**Note:**  
On a D-MAXE 2 Controller, a drive is selected from which the settings for Drive 1 and 2 are also saved. Therefore 2 backups are not required.

**Restore**



You can use the *Restore* menu to set all settings of the D-MAXE Controller to the values of a backup copy.



**Note:**  
On a D-MAXE 2 Controller, a drive is selected from which the settings are saved simultaneously for Drives 1 and 2. Therefore 2 backups are not required.



**Note:**  
On a D-MAXE 2 Controller, "Manual" operation mode must be selected on both drives.

**1y.7.8.1 .. from previous backup**



The settings from a backup saved by the customer are restored.



**Note:**  
If no backup has been performed yet in the D-MAXE system, this menu is not available.

**1y.7.8.2 .. factory settings**



The factory settings are restored.



**Note:**  
This process must only be performed when it has been requested after consultation with an employee of Fife-Tidland GmbH.



**Note:**  
If nothing appears in the operator interface display after a restart, select a device with the header  
Then commissioning of the D-MAXE Controller must be performed.

**Device Names**

Device:	D-MAXE
Drive:	D1

- The device name and
- the drive name can be changed.

### 1y.8 Network

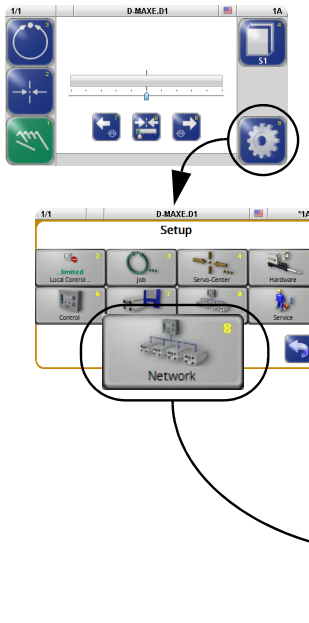

You can use these menus to view network settings and make changes to them.

**Operating modes:**

- The buttons and input fields are available in all operational modes.

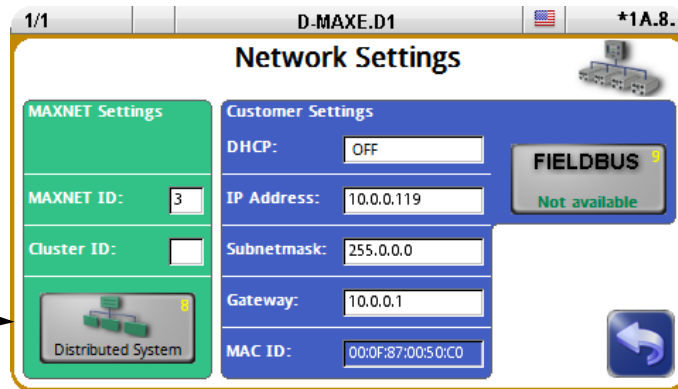

### MAXNET Settings

Display and change the network settings for MAXNET:

- The MAXNET ID is used for addressing of individual D-MAXE devices.
- The Cluster ID is used to
  - operate identical systems in a network.
  - operate more than 31 devices in a network

MAXNET ID	Cluster ID	Use
Cannot be edited	Not visible	A system distributed over several devices and present once in the network
Cannot be edited	Visible and can be edited	A system distributed over several devices and present several times in the network
Can be edited	Visible and can be edited	Grouped independent drives (more than 31 are possible)
Can be edited	Not visible	Independent drives (maximum of 31 possible)

**i** Note:  
 The MAXNET address/the MAXNET cluster address is only to be changed in accordance with the appropriate instructions in "Supplementary Operating Instructions" (see system documentation) or following consultation with a member of staff at Fife-Tidland GmbH.



Note:

If nothing appears in the operator interface display after a restart, select a drive with the header.

### Customer Settings

- Display and change the network settings for TCP/IP
- show the MAC-ID of the D-MAXE controller
- optional:  
Display of the fieldbus type and its properties

### 1y.8.8 Distributed System

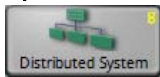

The parameters under the *Distributed System* menu are used to group the devices connected to a common network and their menu structures depending on how they are used and to display them selectively on a D-MAXE operator interface.



Note:

These parameters have no effect on how the connected devices operate. They are evaluated by the operator interfaces only to provide clearer display. Applications that are not set up or are assigned incorrectly have no effect on the functionality of devices.

*Figure 7.7* shows an example of a distributed system consisting of three D-MAXE Controllers and a SE-46 sensor. Each individual element of the distributed system has its own menu structure. These elements must be operated from a separate operator interface OI-TS.

All devices present in the distributed system can be selected in operator interface OI-TS.

- Touch the header and select *Select Device*  
All the devices of the distributed system that are present in the network are displayed.

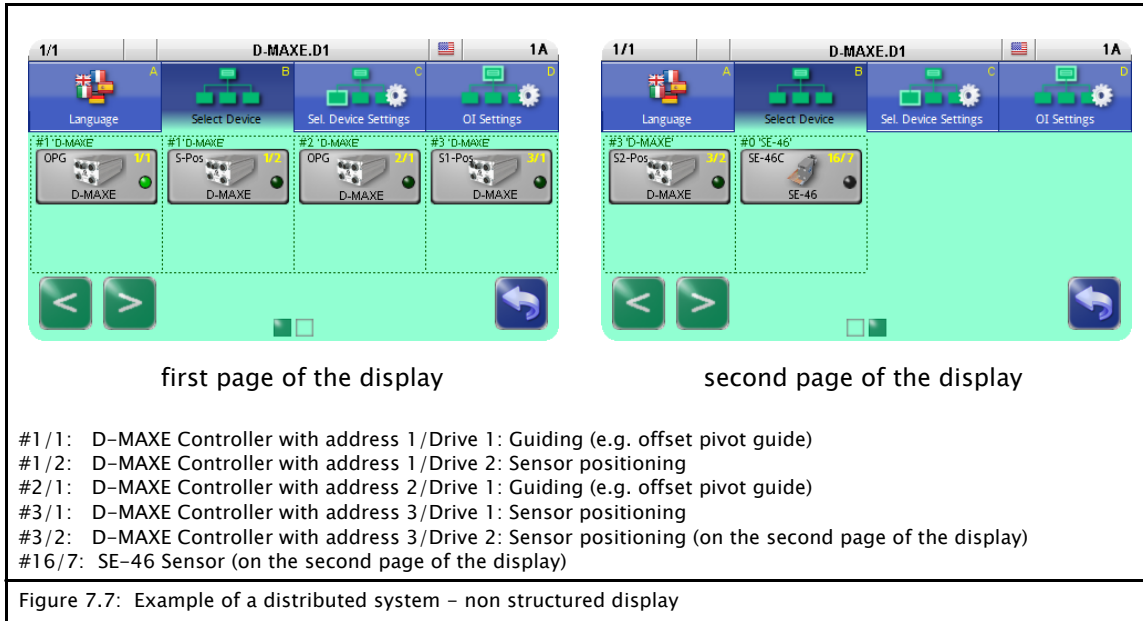

To be able to navigate effectively within such a complex network, individual "devices" and the corresponding menu structures are combined to form applications. Thus an application consists of several menu structures in a distributed arrangement (see [Figure 7.8](#)).

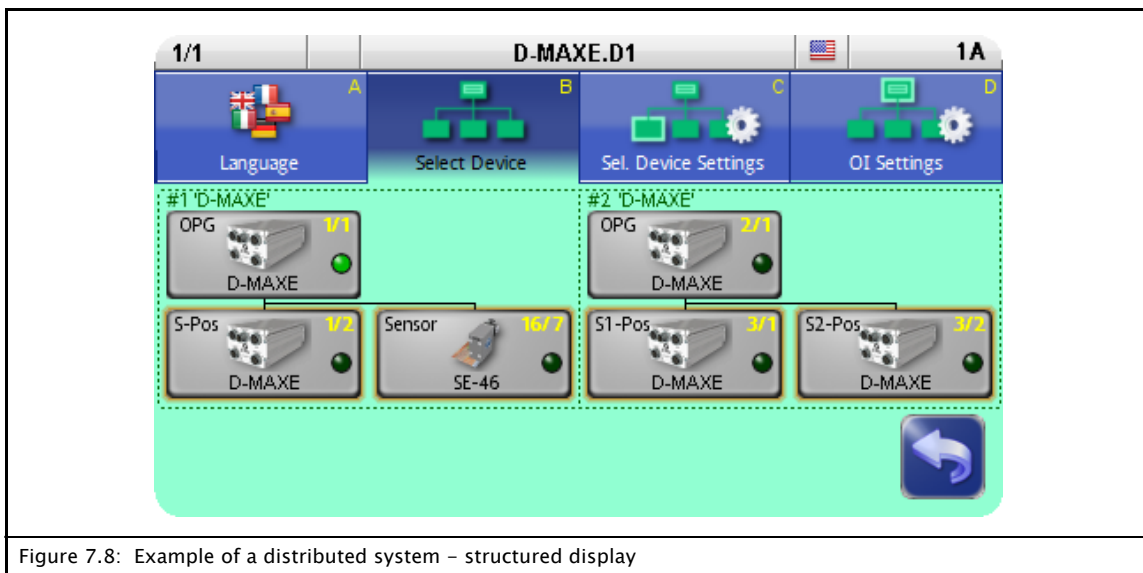



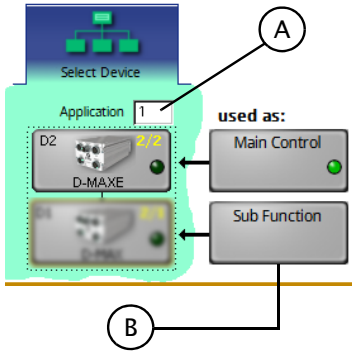

**A: Application**

The *Application* menu provides an orderly summary and names for the menu structures with distributed arrangement (n = 1 ... 99).

All the devices that belong to an application have the same number n.

**B: used as**

Every device inside an application has a *Sub Function* with its menu structure.

A menu structure for each application is marked as the *Main Control*. All other menu structures are *Sub Function*.

### 1y.9 Service

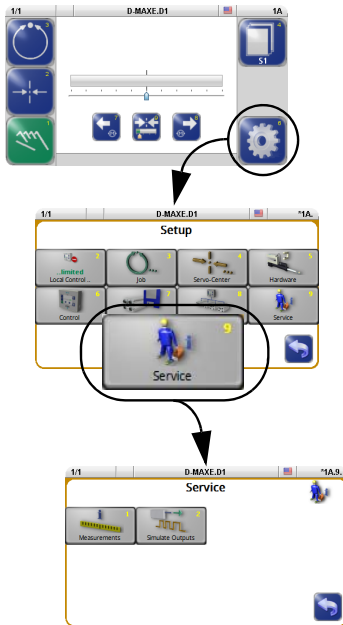

The purpose of these menus is to show information about settings of the D-MAXE system that is important for Customer Service.

**"Manual" mode:**

- All buttons are available.

**"Servo Center" and "Automatic" mode:**

- Only selected buttons are available.

### 1y.9.1 Measurements



Display of values of the D-MAXE system



**1y.9.1.1 Sensors**



**1y.9.1.2 Encoder**



**1y.9.1.3 Digital Inputs (Connection X1)**



**1y.9.1.7 Measured Values**



**1y.9.1.9 Sensor Current**

### 1y.9.2 Simulate Outputs



Used to test components connected to the digital outputs

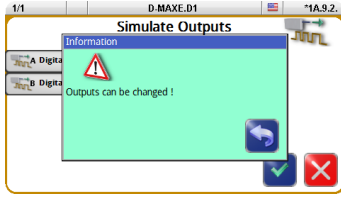

---

**CAUTION:**

Actions may be initiated in the connected components!

---

---

## 8 MAINTENANCE

---



---

**WARNING:**

Danger of injury by crushing

⇒ Maintenance work must only be performed on the D-MAXE system when the power is turned off, the machine is stopped, and it is protected against being turned back on.

---

---

### Maintenance work

No maintenance work is required on the D-MAXE Controller or operator interface.

**To clean the display on the operator interface:**

Depending on how dirty the environment is, carefully wipe off the operator interface display at regular intervals with a soft dry cloth.

If the display becomes very dirty, a moist cloth can be used to clean it. A mild detergent can be used to dissolve grease.

**Note:**

Do not use any solvents or aggressive cleaning agents to clean the display. Doing so could damage the display.

---

## 9 D-MAXE DECOMMISSIONING

---

---

### Decommissioning

1. Turn off the electrical power to the D-MAXE system.
2. Remove all cables from the modules of the D-MAXE system.
3. Disassemble the modules of the D-MAXE system.
4. Modules of the D-MAXE system can be stored according to the specified ambient conditions (see [Transport and storage, page 3-1](#)).

OR

The modules of the D-MAXE system must be disposed of according to national requirements.

---

# 10 TROUBLESHOOTING

---

---

## Troubleshooting Procedure

The D-MAXE system is capable of detecting errors as they occur and displaying them. The system also makes information available that may help exclude possible errors.

## Display possibilities

The following display possibilities are available on modules of the D-MAXE system:

- LEDs on the front sides of the D-MAXE Controller
- Icons in the display of the D-MAXE operator interface

## Procedure

### 1. Check the LEDs on the individual modules of the D-MAXE systems

→ see table [page 10-2](#)

### 2. Check the icons that appear in the display of the D-MAXE operator interface

→ see table [page 10-4](#)

### 3. Check possible causes for faulty behavior. Frequent causes are connections or settings on the D-MAXE system

→ see table [page 10-6](#)

### 4. Check the faulty behavior and possible causes. Often the cause is incorrect parameter settings

→ see table [page 10-9](#)



Note:

The Operating Instructions of other components (e.g. sensors and actuators) should also be consulted for troubleshooting purposes. If there is any customer-specific programming, refer to the "Supplementary Operating Instructions" as well.

### LEDs on the D-MAXE Controller

While the device is being turned on, the LEDs on the D-MAXE Controller are lit red briefly. This makes it possible to check their functionality. The LEDs indicate errors and/or show information about normal operation of the D-MAXE Controller.

LED	Status	Indicates	Remedy
<b>Error messages</b>			
E1 (X2/1)	Off	No Ethernet connection	Check plug and cable
	Yellow	10mbps connection or half-duplex connection	Check switch and cable
E2 (X2/2)	Off	No Ethernet connection	Check plug and cable
	Yellow	10mbps connection or half-duplex connection	Check switch and cable
PR	Off	No power supply	Are the power supplies correctly connected to the X6?  see <a href="#">Electrical connection, page 3-5</a>
	Red	Power supply voltage too low, internal voltage outside tolerance or internal temperature too high	Check voltages and/or temperature  see <a href="#">1y.9.1.7 Measured Values, page 7-27</a>
	Yellow	No motor voltage	Check motor voltages  see item 2 in <a href="#">1y.9.1.7 Measured Values, page 7-27</a>
<b>Information</b>			
E1 E2	Green or Green flashing	Ethernet connection detected	
NW	Green	External device was recognized (e.g an operator interface OI-TS)	
PR	Green	Power supply and temperature are OK	

---







**D-MAXE operator  
interface OI-TS**





Faulty behavior	Possible cause	Remedy
Incorrect actions are performed or none at all	The touch screen is calibrated incorrectly	Test the touch screen (see <a href="#">Debugging, page 4-5</a> ) Recalibrate if necessary (see <a href="#">Settings, page 4-5</a> )



### Icons in the display of the D-MAXE operator interface

The icons in the display of the D-MAXE operator interface provide information about system states. These system states are not necessarily errors; they may also be intended operating states. Therefore these icons must be evaluated individually for troubleshooting to determine whether what seems to be an error may actually be a normal operating state of the D-MAXE system.

Icon	Indicates	Possible error remedy
<b>Error messages</b>		
	No motor voltage	Is the power supply correctly connected to X6?  Note: Two power supplies must be connected to the D-MAXE Controller!  see <a href="#">Electrical connection, page 3-5</a>
	Power feedback through the motor (generator function of the motor)	Are external forces acting on the motor?  Eliminate the external forces  Is the motor under heavy load?  This message appears briefly when heavy loads are being braked.
	Short circuit in the motor cable or motor	Check the motor cable or motor
	No motor detected or no motor connected	If a motor is connected, check the motor and/or cable.
	Error display  An error has been detected on the selected actuator.	Check the voltages  see <a href="#">1y.4.2 Gain, page 7-10</a>
	A threshold of the travel path has been reached. It is only possible to move in one direction – away from this limit.	If this message appears even though no threshold has been reached, the thresholds have been moved.  To restore the basic values, switch to "Servo-center" mode and approach the servo-center position.  If the error persists, check the parameters in <a href="#">1y.4.2 Gain, page 7-10</a> and <a href="#">1y.4.3 Polarity, page 7-10</a> .
	Flashing  The web speed for web speed-dependent guiding is equal to 0.	However, if the web speed is not equal to 0, check the signal for web speed.

Icon	Indicates	Possible error remedy
<b>Error messages</b>		
 and 	The ASC function on the selected actuator has been activated and triggered and the motor is locked.	If locking was not intended, check the sensor signal and ASC thresholds.  see <a href="#">1y.9.1.1 Sensors, page 7-27</a> and <a href="#">1y.3.y6 ASC, page 7-4</a>
	The motor is locked because of an external signal (e.g. PIOX, fieldbus, application control).	If you did not intend for the motor to be locked, check the digital inputs. It is possible that external locking is active  see <a href="#">1y.9.1.3 Digital Inputs (Connection X1), page 7-27</a>  If there is customer-specific programming, refer to the "Supplementary Operating Instructions" in the system documentation for information about the X1 parallel interface.
 or 	The D-MAXE system is expecting commands from external devices.	The devices may not be connected to the network.  Check whether these devices are correctly connected to the network.

## Faulty behavior and setting errors

Often the cause of incorrect or undesirable guiding behavior is an incorrect setting on the D-MAXE system. These errors can easily be eliminated by changing the appropriate settings on the D-MAXE system.

### Possible causes for faulty D-MAXE behavior

Errors caused by connections or settings on the D-MAXE system can result in many kinds of faulty behavior in the system. Often it is difficult to deduce the cause directly from a faulty behavior. You should therefore check the possible causes in the following table and eliminate any that are present.

Possible causes for faulty behavior	Remedy	Reference
No response on the desired actuator. Wrong actuator selected?	Select "Manual mode" and check whether the correct actuator is selected.	<a href="#">Select devices/actuators, page 5-2</a>
 An asterisk "*" appears in the header before the menu identification. Local Control has been taken over.	Limit Local Control. Local Control must be limited to ensure that the system can run as a whole.	see item <a href="#">2 Local Control, page 7-2</a>
Is activation by means of the digital inputs possible?	Check the digital inputs.	see item <a href="#">1y.9.1.3 Digital Inputs (Connection X1), page 7-27</a> in section <a href="#">1y.5 Hardware</a>
Is activation by means of a fieldbus possible (e.g. Profibus) ?	Check the fieldbus status.	see <a href="#">1y.8 Network, page 7-23</a>
	Check the fieldbus data.	see <a href="#">1y.8 Network, page 7-23</a> For more information about fieldbus data, refer to the "Supplementary Operating Instructions" in the system documentation.
Are the digital outputs being used?	Check the status (set/deleted) of the digital outputs.	see item <a href="#">1y.5.4 Digital Outputs, page 7-17</a> in section <a href="#">1y.5 Hardware</a>

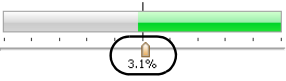
Possible causes for faulty behavior	Remedy	Reference
Sensors	Check the signals of the connected sensors (range $\pm 32767$ ).	see item <a href="#">1y.9.1.1 Sensors, page 7-27</a> in section <a href="#">1y.9 Service</a>
	It may be necessary to recalibrate the sensors.	see item <a href="#">1y.5.1.1.1 Calibration, page 7-12</a> in section <a href="#">1y.5 Hardware</a>
	See also the Operating Instructions for the relevant sensors	
Are encoders being used?	Check whether the encoders are 'counting'.	see item <a href="#">1y.9.1.2 Encoder, page 7-27</a> in section <a href="#">1y.9 Service</a>  For more information about the encoders, refer to the "Supplementary Operating Instructions" in the system documentation.
Are you using the correct motor?	Check the motor	see item <a href="#">1y.5.2 Actuator, page 7-17</a> in section <a href="#">1y.5 Hardware</a> and table <a href="#">Actuators, page 11-6</a>  For further information about the motor refer to the system diagram in the system documentation.
 <p>A cursor appears below the bar graph at the location to which the guide point was moved, together with a numeric entry.</p>	<p>Is the offset of the guidepoint set the way you want it?</p> <p>Correct the guidepoint if necessary.</p>	<a href="#">Shift guide point, page 5-3</a>

Possible causes for faulty behavior	Remedy	Reference
Incorrect results in displays or with web width measurements.	<p>The measurement range is not set or is set incorrectly.</p> <p>Check the measurement range of the sensors and/or encoders you are using.</p>	<p>see item <a href="#">1y.5.1.1.3 Field of View, page 7-13</a> (Sensor) or item <a href="#">1y.5.1..2 Travel Length, page 7-16</a> (Encoder) in section <a href="#">1y.5 Hardware</a></p> <p>For further information see the "Supplementary Operating Instructions" in the system documentation.</p>
	<p>The length unit is set incorrectly.</p> <p>Check the length unit.</p>	<p>see item <a href="#">1y.6.5 Unit, page 7-20</a> in section <a href="#">1y.6 Control</a></p>

**Faulty behavior**

The table below shows examples of faulty behavior, causes, and how to remedy the fault. Often the cause is incorrect parameter settings.

Faulty behavior	Reason	Remedy	Reference
The actuator is moving too fast or too slow.	The motor speed is not set correctly.	Adjust the motor speed	see <a href="#">1y.3.y10 Actuator Speed, page 7-9</a> in section <a href="#">1y.3 Job</a>
The actuator does not move in "Automatic" mode.	The gain is set too low.	Increase the gain	see <a href="#">1y.3.y3 Gain, page 7-4</a> in section <a href="#">1y.3 Job</a>
	The actuator is mechanically locked.	Free the actuator and clean the area.	
The actuator vibrates in the Automatic operating mode..	The gain is set too high.	Reduce the gain	see <a href="#">1y.3.y3 Gain, page 7-4</a> in section <a href="#">1y.3 Job</a>
	Cable connections are loose.	Check all cable connections to make certain they are securely fastened.	
The actuator moves in the wrong direction in "Automatic" mode.	The polarity is set incorrectly.	Reverse the polarity	see <a href="#">1y.3.y8 Polarity, page 7-8</a> in section <a href="#">1y.3 Job</a>
	Wrong job selected.	Select "Manual: mode and check whether the correct job is selected.	see <a href="#">Select jobs, page 5-3</a>
The actuator does not move in "Servo Center" mode.	The gain for the servo-center transducer is set too low.	Increase the gain	see <a href="#">1y.4.2 Gain, page 7-10</a> in section <a href="#">1y.4 Servo-Center</a>
	The actuator is at the stop because the polarity is set incorrectly.	Reverse the polarity for the "Servo-center" operation mode.	see <a href="#">1y.4.3 Polarity, page 7-10</a> in section <a href="#">1y.4 Servo-Center</a>
The actuator vibrates in the "Servo-center" operating mode.	The gain for the servo-center transducer is set too high.	Decrease the gain	see <a href="#">1y.4.2 Gain, page 7-10</a> in section <a href="#">1y.4 Servo-Center</a>

Faulty behavior	Reason	Remedy	Reference
The actuator does not reach the servo-center position in "Servo Center" mode.	The polarity for the servo-center transducer is set incorrectly.	Reverse the polarity	see <a href="#">1y.4.3 Polarity, page 7-10</a> in section <a href="#">1y.4 Servo-Center</a>
	The servo-center transducer is not receiving a signal.	<p>Check the distance between the servo-center transducer and the measuring point.</p> <p><b>WARNING:</b> It may be necessary to move the actuator to adjust the servo-center transducer. There is a risk of cutting injuries on the web and crushing injuries on the actuator. ⇒ Do not touch the edges of the material web. ⇒ Perform the adjustment only when the machine is stopped and protected against being turned on.</p> <p>Type:    Switching Distance ISCT-03: about 1 mm ISCT-20: about 1.5 mm ISCT-21: about 2 mm ISCT-22: about 5 mm ISCT-23: about 10 mm</p>	

---

# 11 TECHNICAL DATA

---

---

## General information

### D-MAX Controller

#### Power supply

24 – 48V nominal  
21V minimum – 51V maximum

The negative pole serves as a signal ground and is electrically connected with the housing.

#### Maximum power consumption

##### D-MAXE Controller – connection for control

130W maximum

##### D-MAXE Controller – connection for drive

200W maximum at 24V or  
400W maximum at 48V

#### Dimensions

Length: 184mm (without cables)  
Width: 87mm  
Height: 60mm

#### Weight

1,0kg

#### Protection class

IP54 according to DIN EN 60529

#### Ambient conditions

Ambient temperature: 0°C to 60°C  
Relative humidity: 10% to 95% non-condensing  
Altitude above sea level: maximum 3000m

#### Maximum output current

4,0A / drive

### D-MAXE operator interface OI-TS

#### Power supply

12 – 24V nominal  
10V minimum – 30V maximum

#### Power consumption

2W



**Dimensions**

Wall mounting: 128 x 105 x 38mm

Desk installation: 128 x 105 x 33+5mm

**Weight**

0.6kg (only the OI-TS, without mounting accessories)

**Protection class**

IP64 according to DIN EN 60529

**Ambient conditions**

Ambient temperature: 0°C to 60°C

Relative humidity: 10% to 95% non-condensing

Altitude above sea level: maximum 3000m

---

**Inputs and outputs of  
the D-MAXE Controller****Communication interface**

based on Ethernet – 100Mbps full duplex\*\*\*\*

**Electromechanical drive**

maximum 4A/drive

**Hydraulic servo-valve**

±50mA

with or without lock valve (24V or 48V, maximum 4A)

**Motor Power Amplifier MPA**

±10mA

with MPA locking signal

**Servo-center transducer**

Analog, inductive servo-center transducer

**Sensor input**

maximum ±20mA

Preset range 0 to 10mA

Sensor inputs can be calibrated individually

**Line Speed**

0 – 10mA

Calibration optionally possible between 0–20mA

**Power supply for accessory devices\*\***

+12V ± 5%, 2000mA total – 12V ± 5%, 150mA total  
+24V ±5%, 1000mA each sensor connection and serial connection\*

\* The supply output at each sensor connection and the serial connection can be individually switched between +12V and +24V. When the control supply input is less than 24V, the +24V output can be 1V below the input supply.

**Parallel interface\*\***

6 digital inputs

Low-level: 0 – 0,9V

High-level: 4.6 – 24V; maximum power consumption 6mA to ground

2 outputs

Optionally switching to positive or ground

Positive switching: 12V (at least 10.3V at 200mA)

Ground switching: 0V (maximum 1.0V at 500mA)

Maximum voltage: 28V

Overcurrent and short-circuit protection

+12V available as auxiliary voltage

\*\* Guiding amplifiers of type D-MAXE 1 and D-MAXE 2 normally have a 0-ohm connection between the primary-side protective ground wire [PE] and the DC-side ground [GND]. This is necessary to meet EMC requirements as specified by VDE 0838, part 3 2002-05 DIN EN 61000-3-3, Electromagnetic Compatibility (EMC) – part 3-3 and to ensure that connected accessory devices (sensors, encoders, actuators and operator interfaces) work properly.

\*\*\* When the control input supply is less than 24V, the positive switching output can be 1V below the input supply.

\*\*\*\*Connectors X2/1 and X2/2 provide access to an integrated two-port Ethernet switch. The dual Ethernet ports in the D-MAXE also support slave mode beacon-based DLR (Device Level Ring) technology and will automatically participate as a beacon-based slave when the DLR protocol is detected. In this mode, the two Ethernet ports function in accordance with DLR traffic rules to provide network redundancy and diagnostic capability.

**Parallel input matrix**

Because of the option for customer-specific programming, there may be some deviations in the parallel input matrix. Customer-specific software adjustments of this type are described in the "Supplementary Operating Instructions" for the D-MAXE system and are included in the system documentation.

Mode	Inputs					
	5	4	3	2	1	0
Locking, external	-	-	-	-	-	H
Automatic	-	-	L	L	H	-
Manual	-	-	L	H	L	-
Servo Center	-	-	H	L	L	-
Move drive left*	L	H	-	-	-	-
Move drive right*	H	L	-	-	-	-
RGPC left*	L	H	-	-	-	-
RGPC right*	H	L	-	-	-	-
RGPC RESET*	H	H	-	-	-	-

L = Low level (<= 0,9V or blank)

H = High level (3,6V – 24V)

Empty field = not relevant for the specific command

\* Inputs 4 and 5 for moving the drive in "Manual" and "Servo Center" modes

Offset of the guide point (RGPC) in "Automatic" mode

**Parallel output matrix**

Status	Outputs	
	B*	A*
LOSS OF NULL (Automatic mode)	-	1
Drive servo-centered (Servo-Center mode)	1	-

The menu [1y.5.4 Digital Outputs, page 7-17](#) can be used to adjust the assignment of the logical state (1 or 0) to the electrical state (active low, active high, high-impedance).

If there are differences compared to the table, they are described in the "Supplementary Operating Instructions" in the system documentation.

## Jobs

	Job	Connection	Type of Guiding
<b>A</b>	S1	X5/1	Edge guiding*
<b>B</b>	S2	X5/2	Edge guiding*
<b>C</b>	S3	X9/1	Edge guiding*
<b>D</b>	S4	X9/2	Edge guiding*
<b>E</b>	S1 - S2	X5/1&2	Center guiding or slave guiding
<b>F</b>	S3 - S4	X9/1&2	Center guiding or slave guiding
<b>G</b>	S1 - S3	X5/1 & X9/1	Center guiding or slave guiding
<b>H</b>	S2 - S4	X5/2 & X9/2	Center guiding or slave guiding
<b>J</b>	X5	X5/2	Line center guiding
<b>K</b>	X9	X9/2	Line center guiding
<b>L</b>	X5	X5/1	Line edge guiding
<b>M</b>	X9	X9/1	Line edge guiding

\* It is possible that the sensor being used is already returning a center signal. In this case, center guiding will be performed.

**Note:**

Because of the possibility of customer-specific programming, individual jobs cannot be present or cannot be used differently than listed in the table. Customer-specific software adjustments of this type are described in the "Supplementary Operating Instructions" for the D-MAXE system and are included in the system documentation.

Actuators

Display content*	Current	**Nom. voltage	Motor / Valve	ID	Typical modules
1.3A MTR/ENC ID0	1,3 A	24 VDC	M352553 Motor encoder	Series ID 00	DS-25
2.0A MTR/ENC ID1	2,0 A	24 VDC	M332325 Motor encoder	Series ID 01	DS-70 D-LA-70
3.3A MTR/ENC ID2	3,3 A	24 VDC	M281466 Motor encoder	Series ID 02	GMA-D1
3.3A MTR/ENC ID3	3,3 A	24 VDC	M352554 Motor encoder	Series ID 03	DLAB-3-6
0.8A MTR/ENC ID4	0,8 A	24 VDC	M280791 Motor encoder	Series ID 04	D-Pro-Trac 200
4.0A MTR/ENC ID5	4,0 A	24 VDC	M315031 Motor encoder	Series ID 05	GMA-D3
0.4A MTR/ENC ID7	0,4A	24 VDC	M280791 Motor encoder	Series ID 07	D-PT-150
0.6A M/ENC(EGH) ID8	0,6A	48 VDC	M388282 Motor encoder	Series ID 08	D-Pro-Trac 200
0.6A NO TACH 2,05K	0,6 A	48 VDC	M352555 Motor (tachless)	2,05K	Tachless Symat 25
1.3A NO TACH 3,48K	1,3 A	48 VDC	M351418 Motor (tachless)	3,48K	Tachless Symat 50
0.2A NO TACH 5,11k	0,2 A	24 VDC	M319177 Motor (tachless)	5,11K	Pro-Trac 150
0.6A MOTOR 6,81K	0,6 A	48 VDC	M136115 Motor	6,81K	Pro-Trac 200
0.6A MOTOR 8,66K	0,6 A	48 VDC	M328091 Motor	8,66K	MicroSymat Symat 25
8,0A MOTOR 11K	8,0 A	36 VDC	M137384 Motor	11K	AG-11, AB-12, LAB-8
1.3A MOTOR 14K	1,3 A	48 VDC	M136112 Motor	14K	Symat 70
			M126687 Motor		Symat 50
1.3A MOTOR 14K	1,3 A	48 VDC	M126688 Motor	14K	GMA-1
1.6A MOTOR 16,9K	1,3 A***	48 VDC	M136103 Motor (1,6 A)	16,9K	GMA-1
0.4A MOTOR 20,5K	0,4 A	48 VDC	M352556/ M352557 Motor	20,5K	NarroWeb 25
2.0A MOTOR 24,9K	2,0 A	48 VDC	M136111 Motor	24,9K	GMA-3
2.6A MOTOR 30,1K	2,6 A	48 VDC	M146713 Motor	30,1K	LAB-10, LAB-10A
0.6A MOTOR 8,66K	0,6 A	48 VDC	M136105 Motor	8,66K	LA-9
3.5A MOTOR 36,5K	3,5A	48 VDC	M126246 Motor	36,5K	AB-1
			M126687 Motor		LRA

TechnDaten.fm

Display content*	Current	**Nom. voltage	Motor / Valve	ID	Typical modules
1.0A MOTOR 44,2K	1,0 A	48 VDC	M352559 Motor M352560 Motor	44,2K	NarroWeb 50
50mA HYDR 64,9K	±50 mA	24 VDC	Hydraulic proportional valve	64,9K	
48V LVALVE 78,7K	0,6 A	48 VDC	Hydraulic proportional valve and 48 V locking valve	78,7K	
24V LVALVE 95,3K	1,2 A	24 VDC	Hydraulic proportional valve and 24 V locking valve	95,3K	
50mA HYDR AXC 121K	±50 mA	24 VDC	Hydraulisches Servoventil	121K	Zero-overlapped valve
48V LVALVE AXC 154K	0,6 A	48 VDC	Hydraulic servo-valve	154K	Zero-overlapped valve with 48V locking valve
24V LVALVE AXC 205K	1,2 A	24 VDC	Hydraulic servo-valve	205K	Zero-overlapped valve with 24V locking valve
10mA MPA 287K	±10 mA	24 VDC	MPA Motor driver	287K	MPA-01 / -02 / -30
CUSTOM MTR 825K	Adjusted motor			825K	Not a motor from Fife
-	No motor or valve detected.			None	

\* see [1y.5.2 Actuator, page 7-17](#)

\*\* The maximum possible mains power voltage on the D-MAXE Controller is 51 VDC. The D-MAXE Controller regulates the voltage down to the necessary level required by the connected motor/valve.

\*\*\* 1,3A is used for the 1.6A motor.

**Cable lengths**

Connection	Cable lengths (maximum)
Sensors (except SE-26 / -26A)	50m
Sensor SE-26A	25m
Parallel interface	50m
Servo-center transducer	50m
Servo-valves	50m
Locking valve	50m
Drive	14m
RGPC-50	100m
Ethernet	100m
Operator interface	50m

**Standards**

Modules of the D-MAXE system have been engineered according to the standards and guidelines of the European Union. A declaration of conformity is available on file.

Modules of the D-MAXE system are in compliance with the following standards:

EN 61326-1	Radiated Emissions	Class A
	Conducted Emissions	Class A
FCC 47 CFR Part 15		Class A
ANSI C63.4		Class A
EN 61000-4-2		4kV/8kV
EN 61000-4-3		10Vrms
EN 61000-4-4		2kV/1kV
EN 61000-4-5		2kV/1kV
EN 61000-4-6		3Vrms

---

**Accessories (optional)****Input devices****RGPC-50/51**

External input device for moving the guidepoint

**RCAL-20**

External input device for easier sensor calibration of edge sensors

**RCAL-26**

External input device for easier sensor calibration of line sensor SE-26/SE-26A

**Assembly accessories**

Wall bracket for D-MAXE Controller

Wall bracket for operator interface



# 12 APPENDIX A – OVERVIEW

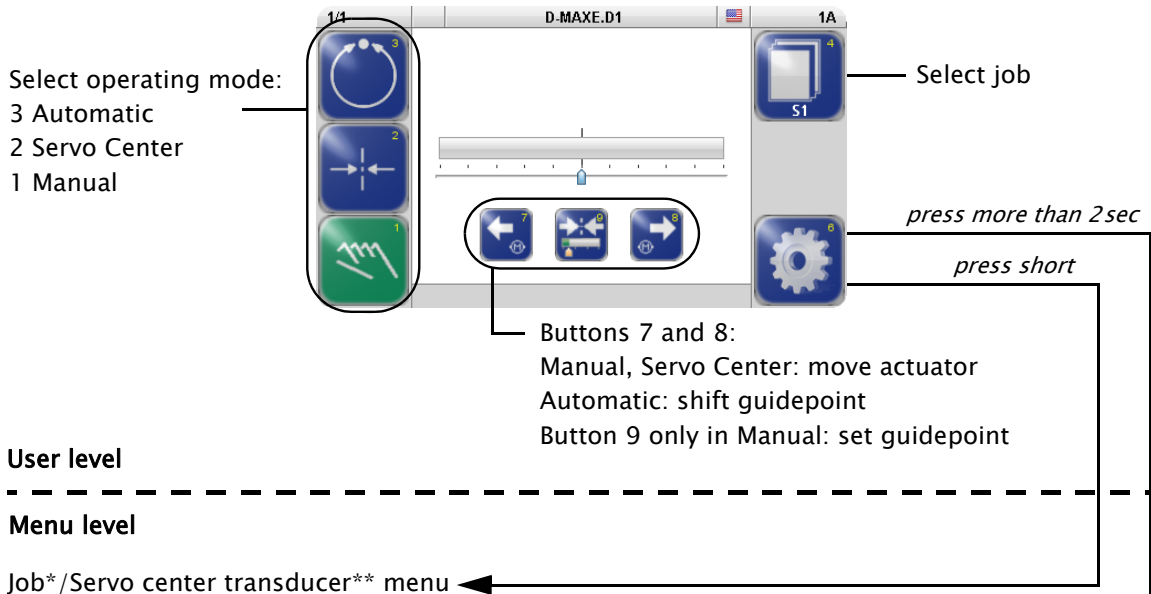

User level

Menu level

Job\*/Servo center transducer\*\* menu

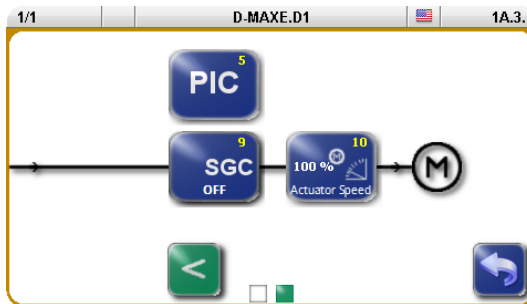
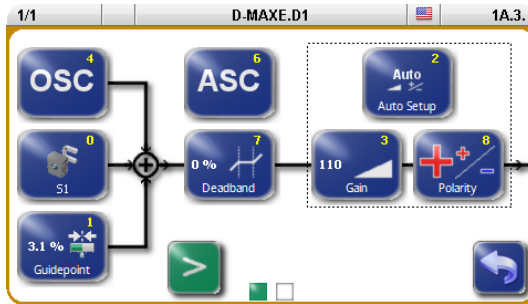

\* Operating mode Manual/Automatic

- 0 Calibrate sensor
- 1 Guidepoint
- 2 Auto Setup
- 3 Gain
- 4 OSC
- 5 PIC
- 6 ASC
- 7 Deadband
- 8 Polarity
- 9 SGC (Speed Gain Control)
- 10 Actuator Speed

\*\* Operating mode Servo Center

- 1 Guidepoint
- 2 Gain
- 3 Polarity

Setup menu \*\*\*

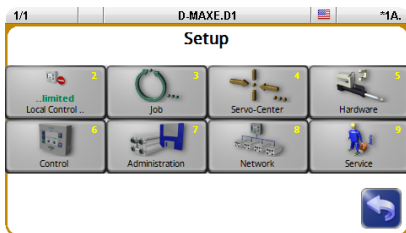

- 2 Local Control
- 3 Job  
Switch to Job menu
- 4 Servo-Center  
Switch to Servo-Center transducer menu

















- 5 Hardware
  - 1 Sensors
  - 2 Actuator
  - 3 Digital Inputs
  - 4 Digital Outputs
- 6 Control
  - 1 Modes
  - 2 Jobs
  - 3 Left/Right buttons
  - 4 Local Control
  - 5 Unit
  - 6 Hardlock
- 7 Administration
  - 1 Labels
  - 2 Serial Number
  - 3 Backup & Restore
  - 4 Device Names

- 8 Network
  - MAXNET Settings
  - Customer Settings
- 9 Service
  - 1 Measuring Points
  - 2 Set Digital Outputs

\*\*\* the set of menus depends on the selected operating mode and/or on the programming

Übersicht:fm

## 13 APPENDIX B – SYMBOLS

Symbols	Description
	Error display – This icon appears if an error is detected on the selected drive.
	The selected drive is expecting MAXNET data from a device, but does not receive any data. The device that should send MAXNET data is either not connected or not turned on.
	The selected drive expects data from a Gateway, but does not receive any data, since no data can be received on the Gateway.
	No motor was detected or no motor is connected.
	The motor current supply is outside the valid range.
	Motor backfeed overvoltage (generator function of the motor) or short circuit in the motor cable.
	The motor is locked
	The motor works at maximum motor current.
	The motor is actively locked in "Manual" mode (hardlock).
	The limit values of the encoder have been reached.
	RCAL is active on the selected drive. This symbol appears between the time when the first and second button on the RCAL-20/26 (optional device) is pressed.
	The optional oscillator 'OSC' is available in the selected job.
	The optional controller 'PIC' is available in the selected job.
	SGC: Guiding depends on the web speed. If this symbol is flashing, the web speed is equal to 0 and no guiding is being performed.
	ASC (Automatic Signal Control) is activated.
	ASC is triggered. This icon appears if the ASC function has been activated and triggered on the selected drive.
	ASC is triggered. These icons appear if the ASC function has been activated and triggered on the selected drive and the motor has been blocked.

---

## 14 APPENDIX C – TERMS

---

**ASC (Automatic Signal Control)**

If the web is outside of the defined range of the sensor's field of vision, guiding is stopped.

**Automatic**

Operating mode

The web course is automatically corrected by an actuator based on sensor information.

**Automatic calibration**

The Gain and Polarity parameters are calibrated automatically.

**CM (Customized Menu)**

Customer-specific system menu

This system menu is only present if the D-MAXE controller has been programmed accordingly.

**Deadband**

A range is defined around the guide point in the sensor field of view in which guiding is reduced or is not active at all in the "Automatic" operation mode.

**Device**

Devices refer to the drives on the D-MAXE Controllers present on D-MAXE the network as well as any customer-specific CM system menus or Gateways.

**Drive**

The drive may be the motor of an actuator, for example, which provides the necessary correction within a control loop.

**Encoder**

Incremental position transducer to record positions

**Hardlock**

The Hardlock parameter allows you to maintain the actuator active in its position in "Manual" mode.

**Job**

Jobs are types of controllers that are in principle available in a D-MAXE system.

**LOSS OF NULL**

In "Automatic" operation mode, indicates that the actuator will be moved at more than 50% of its maximum speed to compensate for a guiding error.  
This target speed depends on the guiding error and the set gain.

**LS (Line Speed)**

Designation of the web speed signal which is supplied to X1.

**Manual**

Operating mode  
There is no guiding of the web course.

**OI (Operator Interface)**

Designation of an operator interface.

**OSC**

Designation of an optionally available oscillator.

**PIC**

Designation of an optionally available controller.

**RCAL**

Designation of an external input device for sensor calibration

**RCAL**

Designation of an external input device for sensor calibration.

**RGPC (Remote Guide Point Control)**

Designation of an external activation system for offset of the guidepoint.

**SC (Servo Center)**

SC is the abbreviation for the "Servo Center" mode.

**Servo Center**

Operating mode  
The actuator is moved to the mechanical center position depending on the servo-center transducer.

**Servo-center position**

Then the control rollers of the actuator are aligned parallel to the rollers of the customer system.

**Servo-center transducer**

Assigns the servo-center position for "Servo Center" mode

**SGC (Speed Gain Control)**

Guiding depends on web speed.

**Supplementary Operating Instructions**

Customer-specific software adjustments of the software are described in the "Supplementary Operating Instructions" for the D-MAXE system and are included in the system documentation.

**Web / strip**

The web / strip is the customer's material, which is affected in its direction of movement as it is guided by the D-MAXE system.

For simplicity sake, these Operating Instructions will refer only to the web.

---

## 15 SERVICE

---



---

### Requests for Service

When requesting service, please have a copy of the order confirmation ready with the order number.

When ordering replacement parts, please indicate, (where possible) Part Number, Drawing Number and Model description (see [page 3-1](#)).

Please be careful to keep all documents accompanying the product in a safe place. This will allow us to help you more quickly in the event that service is required.

---

### Addresses

To request service, or if you need replacement parts, please contact one of the following addresses.

#### Fife-Tidland GmbH

Max-Planck-Straße 8                      Siemensstraße 13-15  
 65779 Kelkheim                            48683 Ahaus  
 Deutschland                                Deutschland  
 Telefon: +49.6195.7002.0  
 Fax: +49.6195.7002.933  
 E-Mail: [service@maxcess.eu](mailto:service@maxcess.eu)  
 Web: [www.maxcess.eu](http://www.maxcess.eu)

#### Maxcess

222 West Memorial Road  
 Oklahoma City, OK 73114, USA  
 Telefon: +1 – 405 – 755 – 1600  
 Fax: +1 – 405 – 755 – 8425  
 E-Mail: [service@maxcessintl.com](mailto:service@maxcessintl.com)  
 Web: [www.maxcessintl.com](http://www.maxcessintl.com)



AMERICAS  
 Tel +1.405.755.1600  
 Fax +1.405.755.8425  
[sales@maxcessintl.com](mailto:sales@maxcessintl.com)  
[www.maxcessintl.com](http://www.maxcessintl.com)

EUROPE, MIDDLE EAST  
 AND AFRICA  
 Tel +49.6195.7002.0  
 Fax +49.6195.7002.933  
[sales@maxcess.eu](mailto:sales@maxcess.eu)  
[www.maxcess.eu](http://www.maxcess.eu)

CHINA  
 Tel +86.756.881.9398  
 Fax +86.756.881.9393  
[info@maxcessintl.com.cn](mailto:info@maxcessintl.com.cn)  
[www.maxcessintl.com.cn](http://www.maxcessintl.com.cn)

INDIA  
 Tel +91.22.27602633  
 Fax +91.22.27602634  
[india@maxcessintl.com](mailto:india@maxcessintl.com)  
[www.maxcess.in](http://www.maxcess.in)

JAPAN  
 Tel +81.43.421.1622  
 Fax +81.43.421.2895  
[japan@maxcessintl.com](mailto:japan@maxcessintl.com)  
[www.maxcess.jp](http://www.maxcess.jp)

KOREA, TAIWAN,  
 AND SE ASIA  
[asia@maxcessintl.com](mailto:asia@maxcessintl.com)  
[www.maxcess.asia](http://www.maxcess.asia)