

Achtung ! Kopie  
nicht maßstäblich !

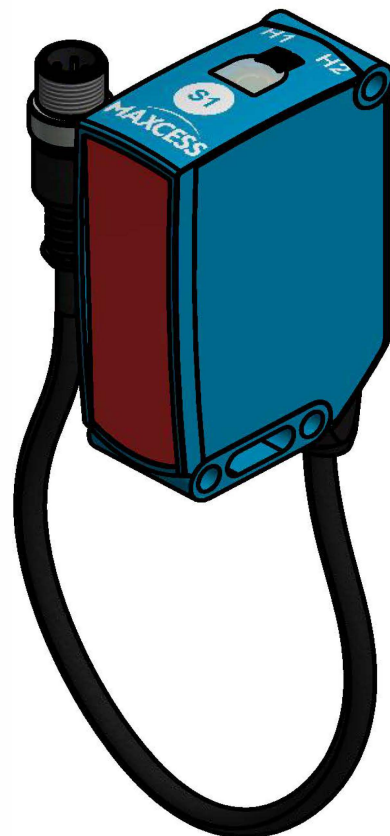

0°

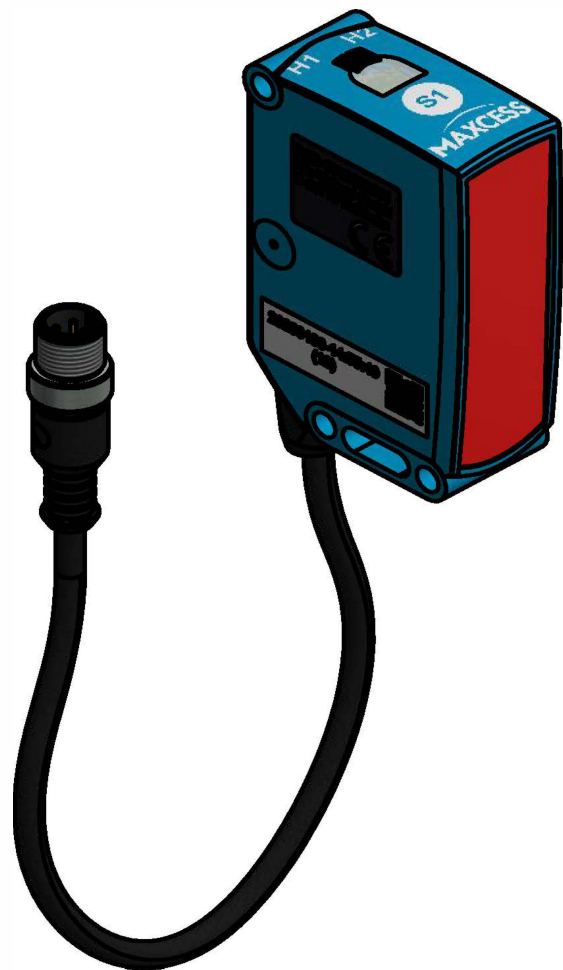
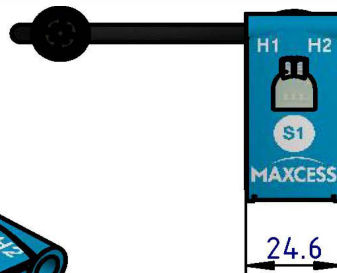
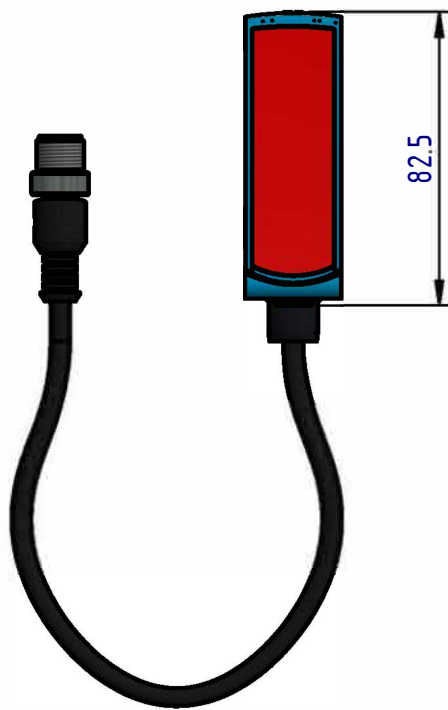
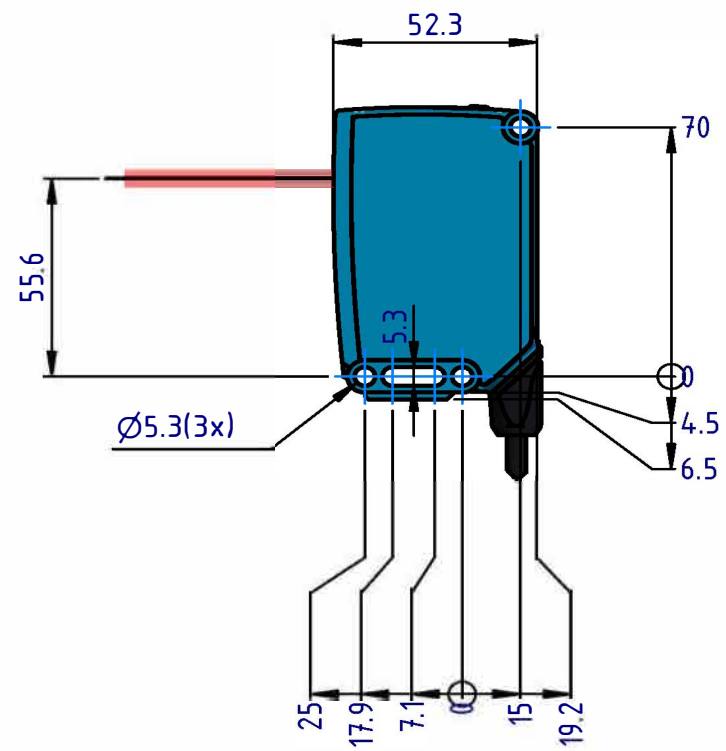
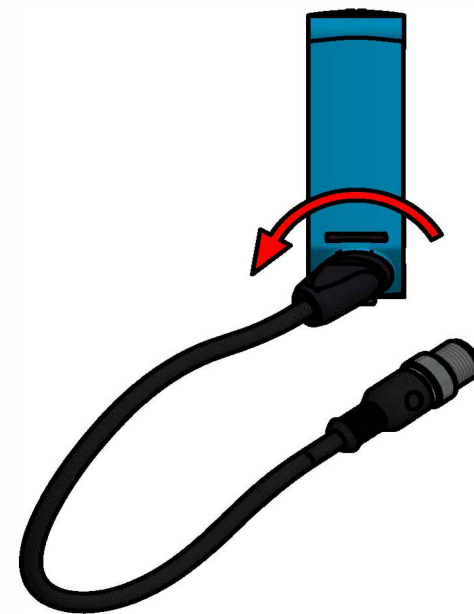

90°

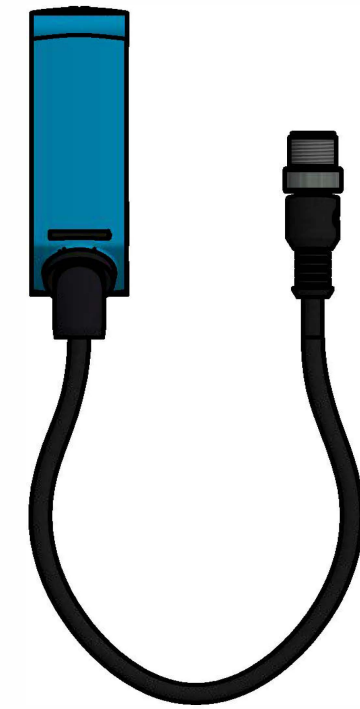

180°



270°

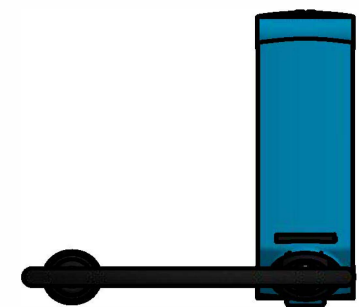

protection mark according  
to DIN 34 / DIN ISO 16016

Schutzvermerk nach  
DIN 34 / DIN ISO 16016

Zulässige Abweichung nach DIN ISO 2768 T1 -m- DIN ISO 2768 T2 -K-		<b>MAXCESS</b> 		Benennung <b>REFLEXLICHTSENSOR</b> DSE-15 MIT KABEL L= 0,3m				Blatt 1/1	
Oberflächentoleranz nach DIN ISO 1302				Format	Maßstab	Maßeinheit	Key	Teilenummer	Zeichnungsnummer
Referenz-Zeichnung	Gewicht	A3	1 : 2	mm		M452951	807311	002	
CAD-System IV2018	Projektion 	Bearb.	13.06.2019	ftrillin	001	Tastensymbol geändert		23.09.2019	ftrillin
		Gepr.			002	Anderung der Position des Typenschildes		10.04.2020	el sklein
SCHUTZVERMERK NACH DIN 34 / DIN ISO 16016		PROTECTION MARK ACCORDING TO DIN 34 / DIN ISO 16016		ACHTUNG! KOPIE IST NICHT MAßSTÄBLICH!		ATTENTION! COPY IS NOT TO SCALE!			